

# Mini-Toetanchamon

228 onderdelen

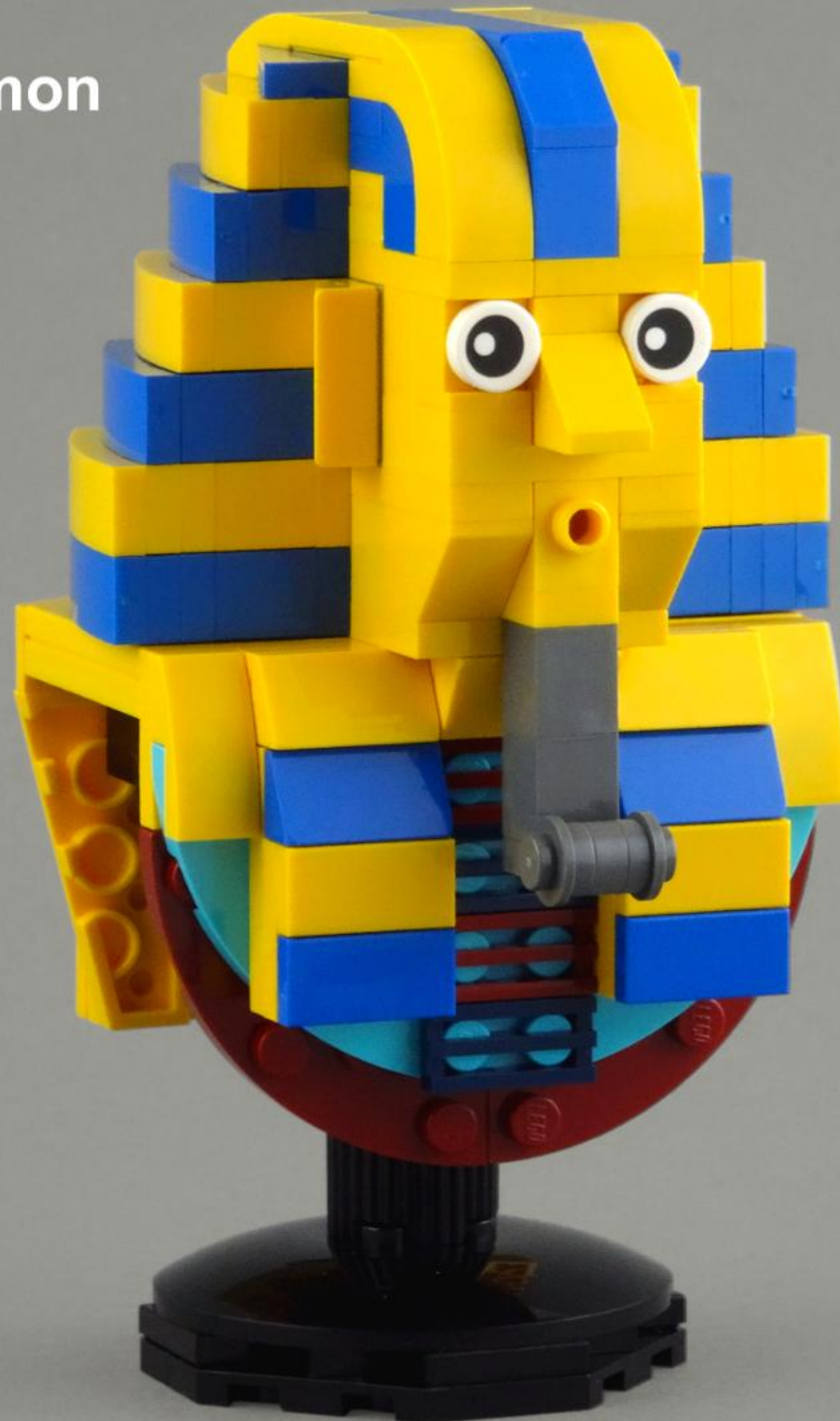



## Op zoek naar Toetanchamon

In het Rijksmuseum van Oudheden is vanaf 10 oktober 2020 de tentoonstelling 'Op zoek naar Toetanchamon' te zien. Je gaat met het opgravingsteam op zoek naar het verborgen graf van de farao. Daarna kom je in de tombe terecht en leer je meer over het Oude Egypte. Tenslotte onderzoek je in het laboratorium Toetanchamons gemummificeerde lichaam. Meer weten? Kijk op [rmo.nl/toet](http://rmo.nl/toet)

## Toetanchamon van LEGO® steentjes

De grote Toetanchamon is gemaakt door Koen Zwanenburg, ook wel bekend als Swan Dutchman. Hij is een grote fan van LEGO® en een liefhebber van geschiedenis. In november 2019 is hij begonnen met het ontwerpen en bouwen van een replica van het wereldberoemde grafmasker. Dat duurde een half jaar en er zitten maar liefst 16.000 steentjes in.

Speciaal voor jou heeft Koen een mini-Toetanchamon ontworpen die je zelf kan bouwen met je eigen LEGO® steentjes. Heb je niet alle onderdelen? Geeft niet! Gebruik je fantasie en kijk of je andere vormpjes en kleurtjes kan gebruiken. Veel bouwplezier!

Bekijk meer bouwwerken van Koen op:  
[www.flickr.com/photos/swandutchman](http://www.flickr.com/photos/swandutchman)  
[www.facebook.com/swandutchman](http://www.facebook.com/swandutchman)

© Koen Zwanenburg, 2020

License to publish granted to Rijksmuseum van Oudheden in Leiden, The Netherlands.

LEGO® is a trademark of the LEGO Group of companies which does not sponsor, authorize or endorse these instructions.



## Toetanchamon op LEGO® IDEAS

Koen heeft nog een ontwerp gemaakt, een kleine replica van het grafmasker bestaande uit circa 750 steentjes. Hij probeert via het platform LEGO® IDEAS dit idee om te zetten in een echte LEGO® set die je kan kopen in de winkel. Om een kans te maken heeft hij 10.000 supporters nodig. En jij kan daarbij helpen! Hoe? Ga naar de website van LEGO® IDEAS ([ideas.lego.com](https://ideas.lego.com)) en tik in het zoekveld 'tutankhamun'. Daar vind je het project zoals hier afgebeeld. Klik vervolgens op de blauwe 'support' knop.



1

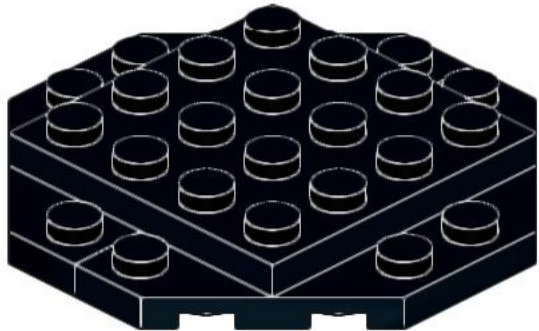
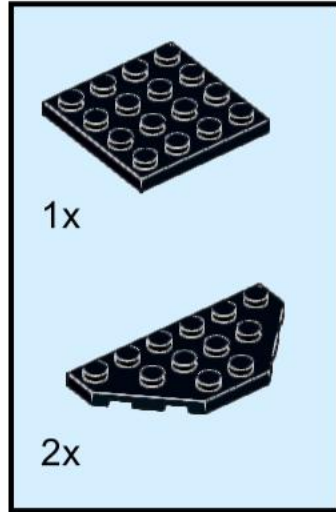
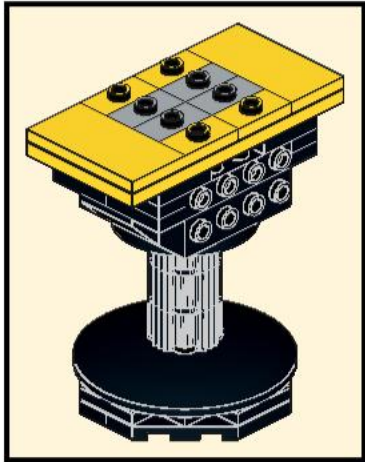

2

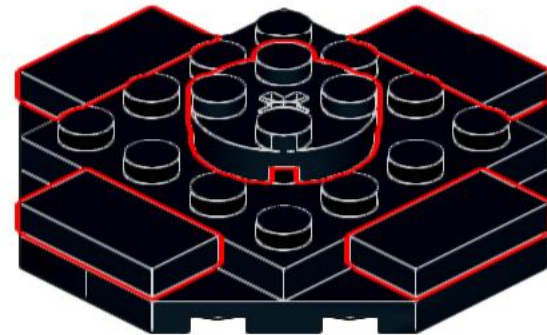
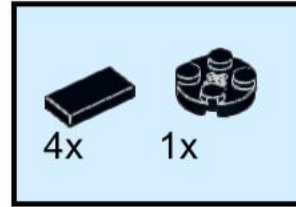

3

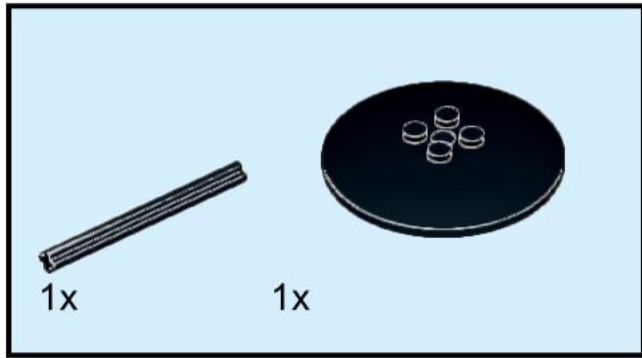

4

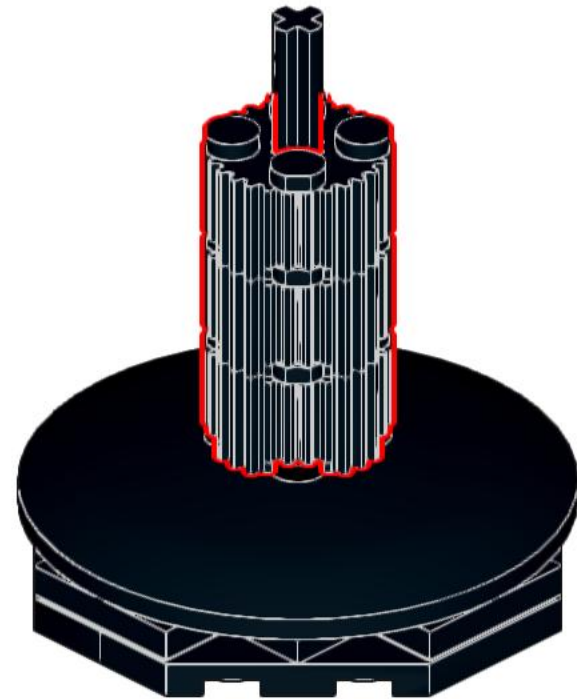

5

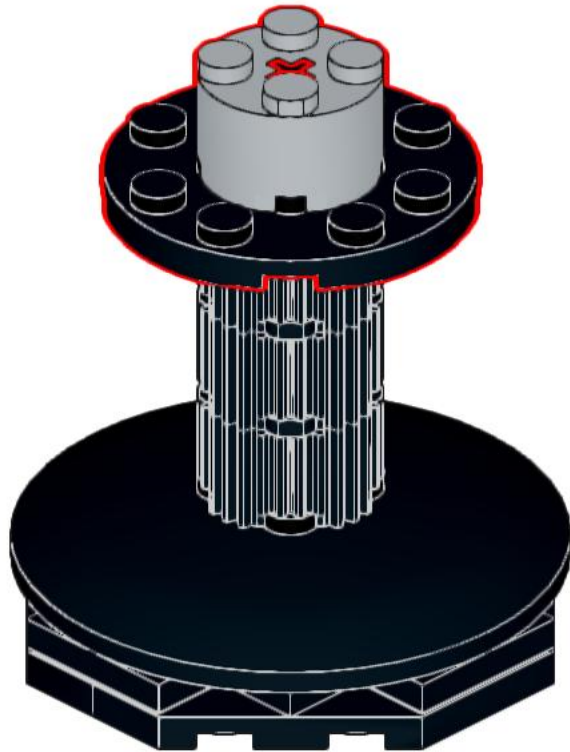
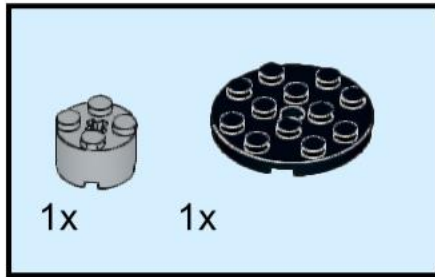

6

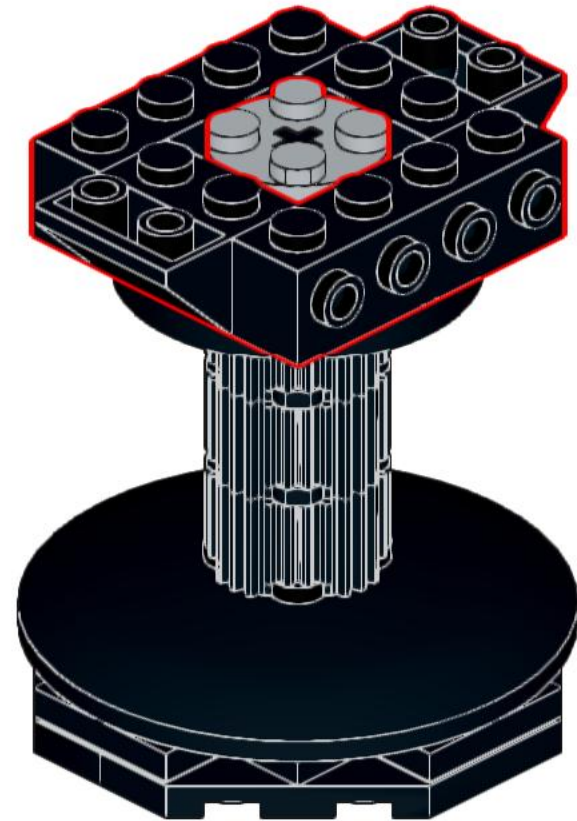
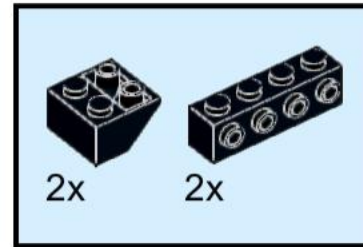



7

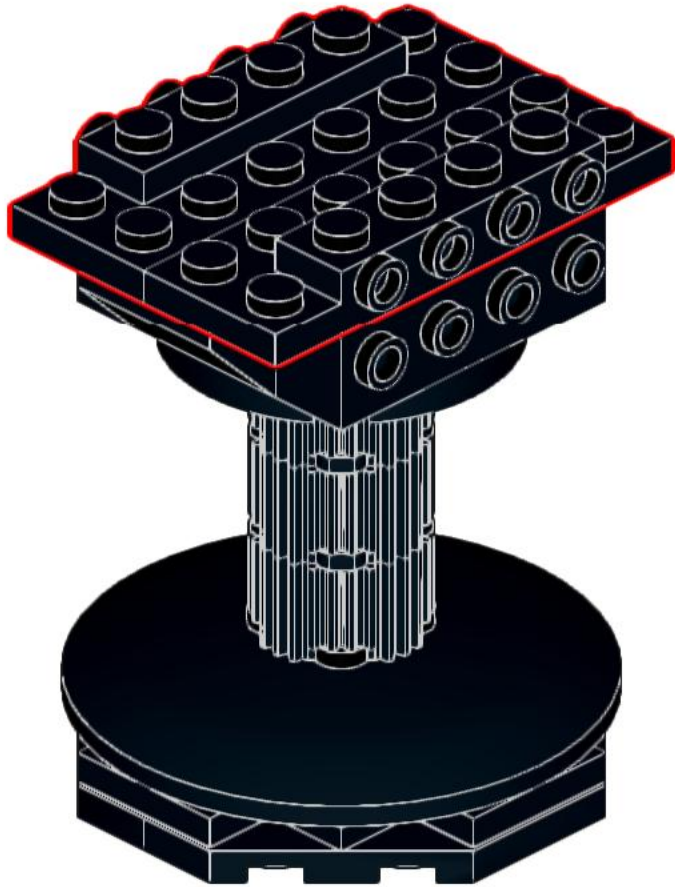
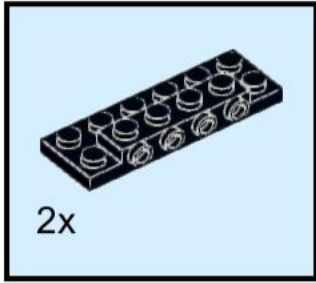

8

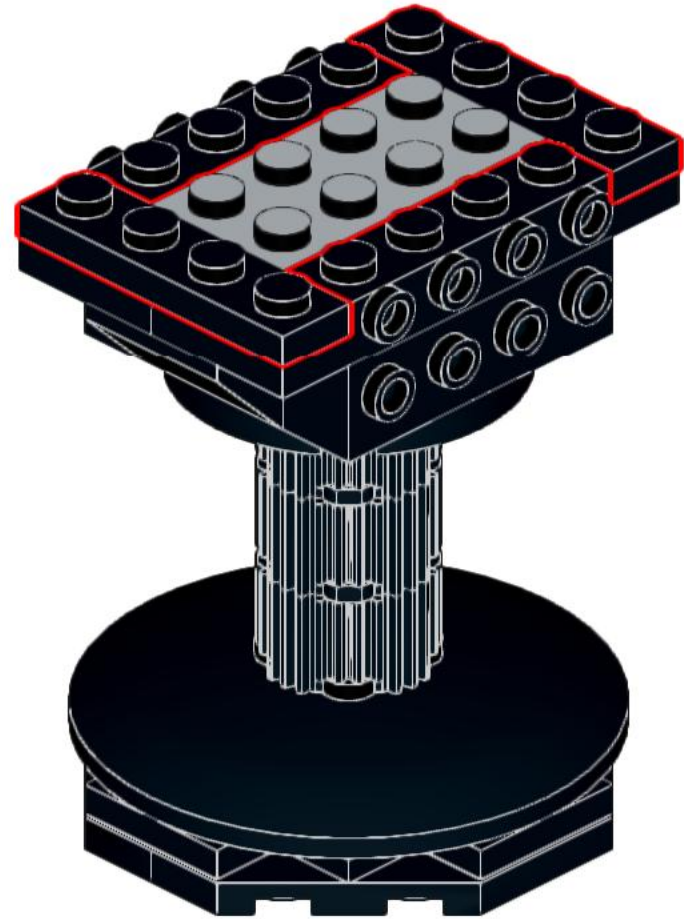
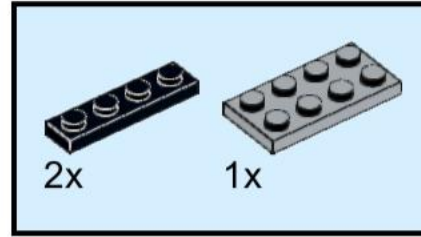

9

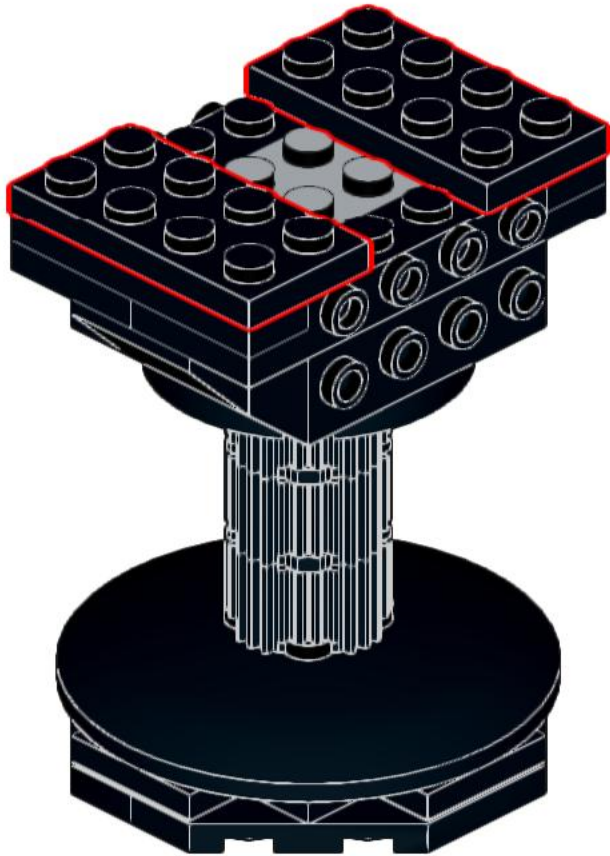
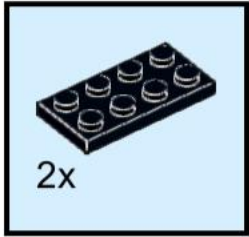

10

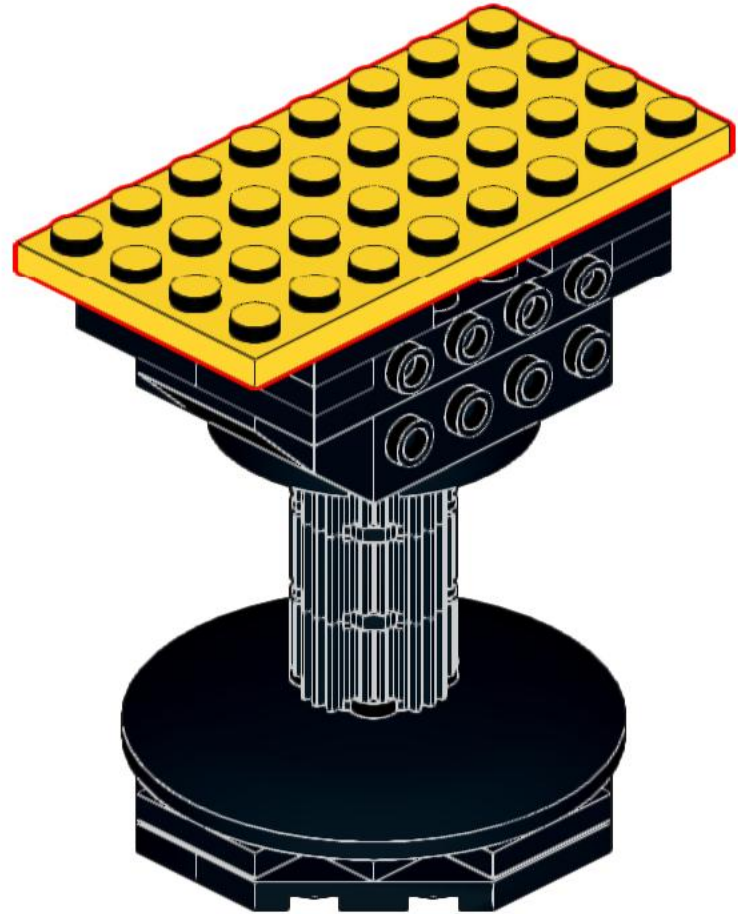
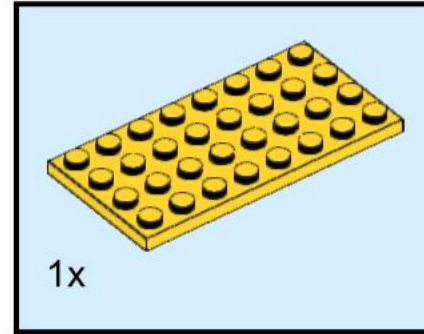



# 11

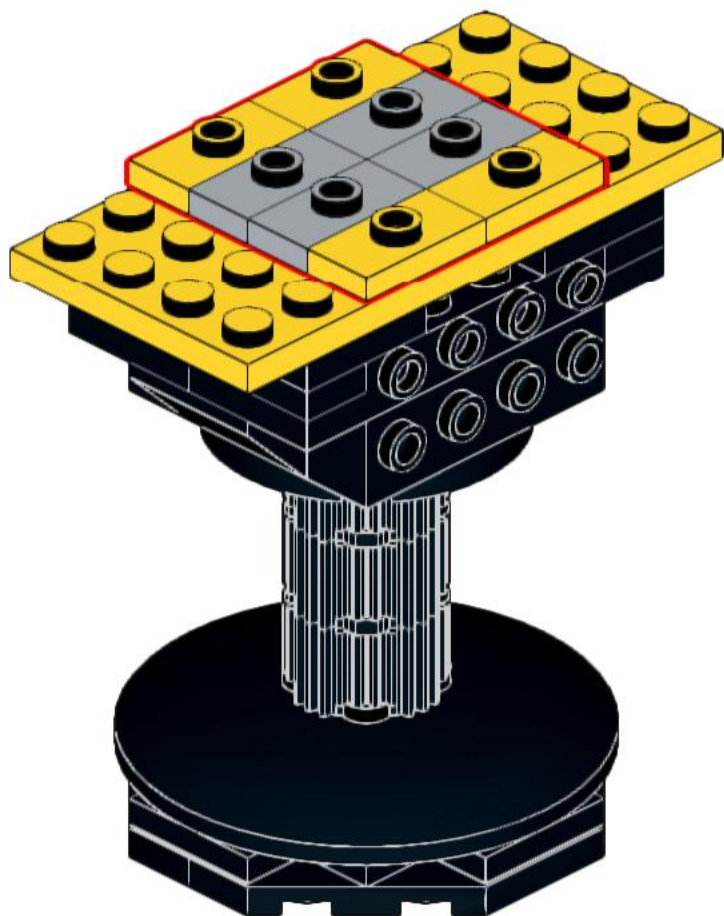
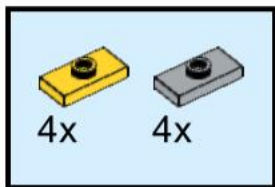

# 12

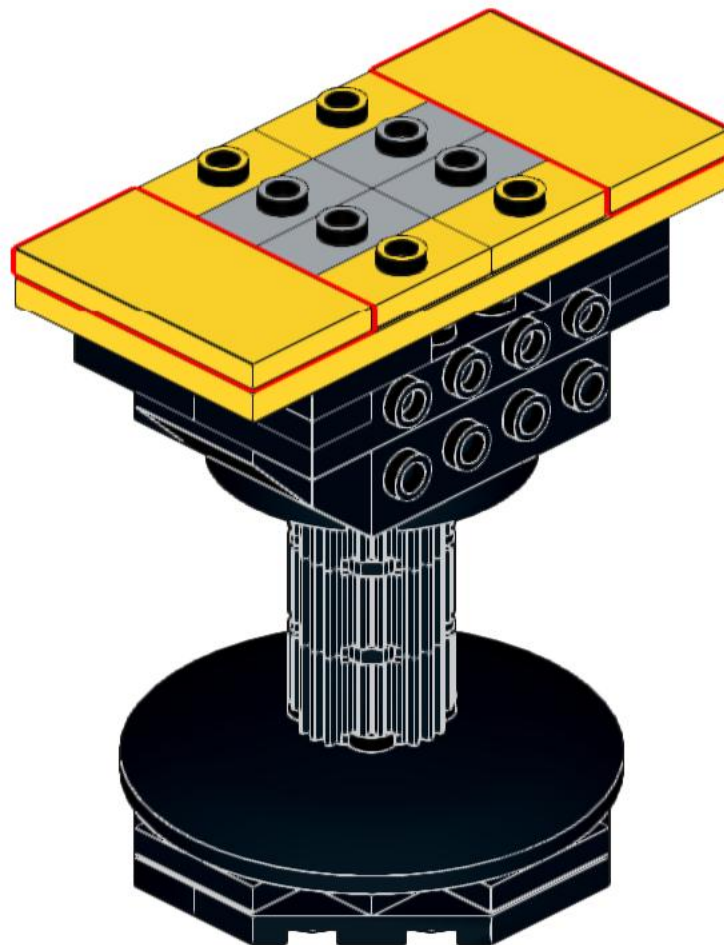
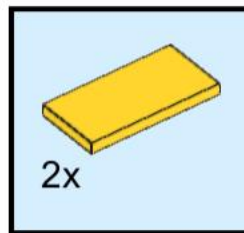

# 13

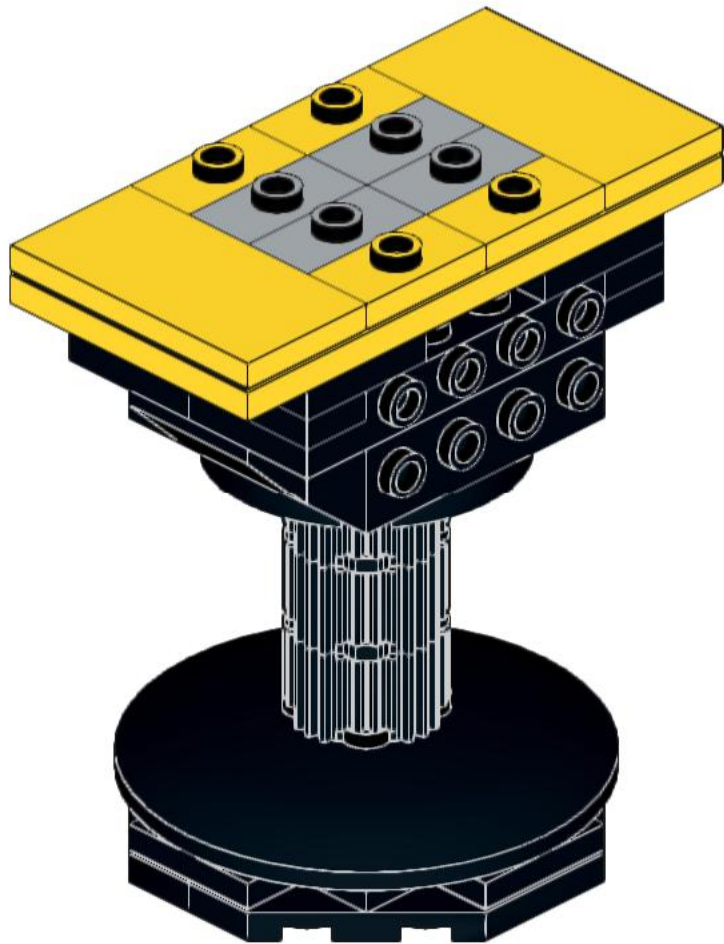

# 14

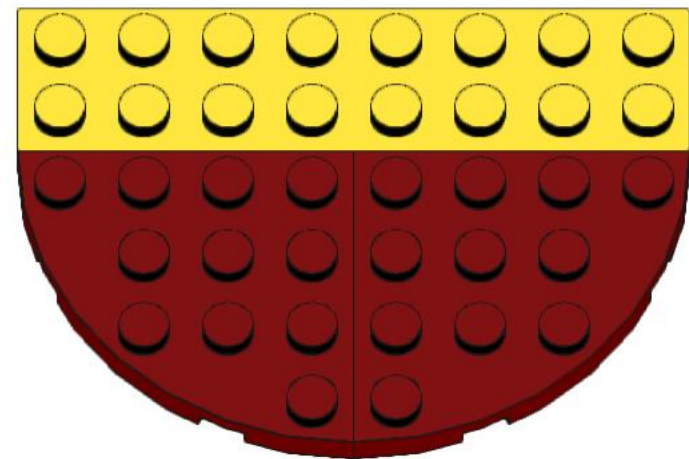
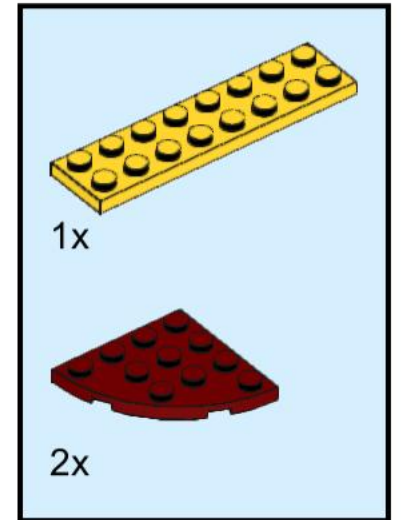
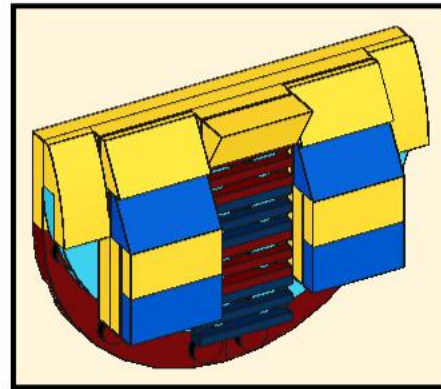

# 15

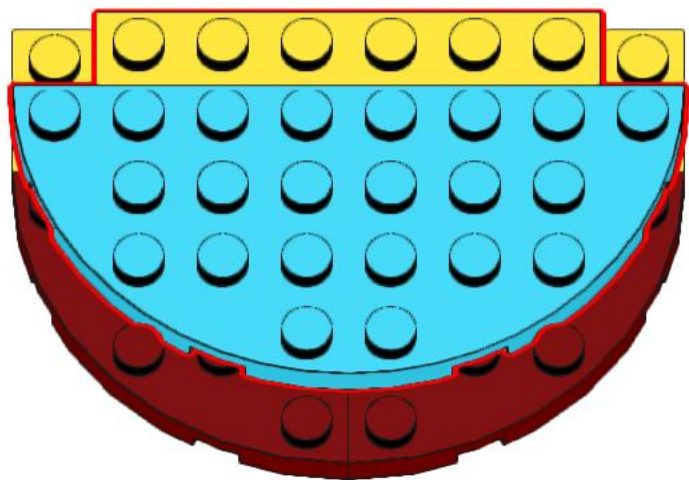
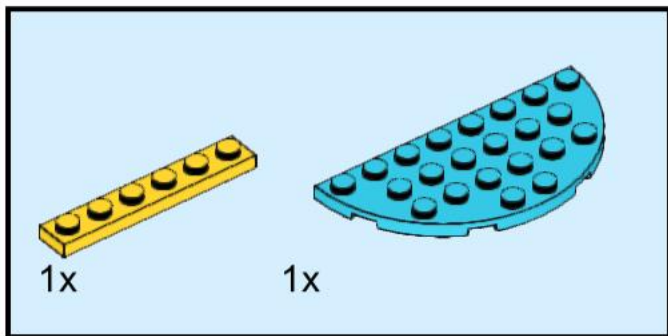

# 16

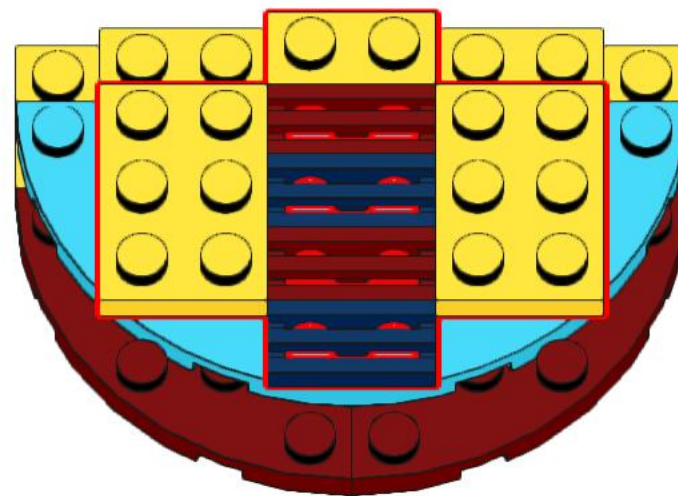
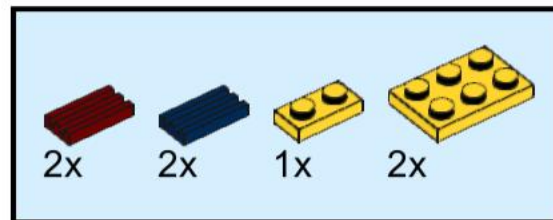



# 17

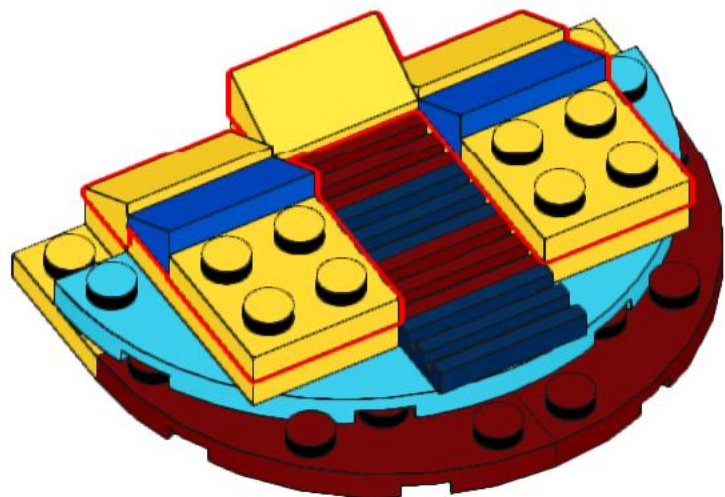
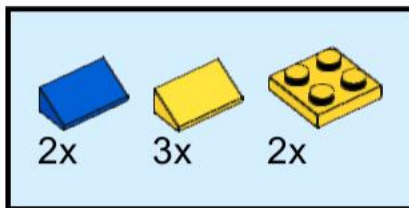

# 18

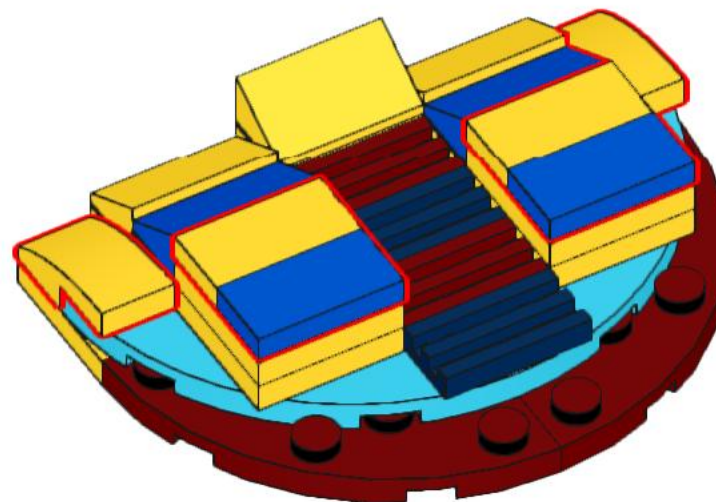
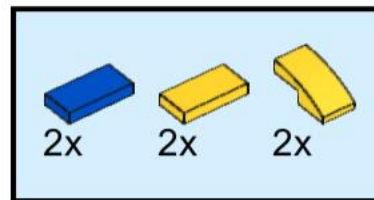

# 19

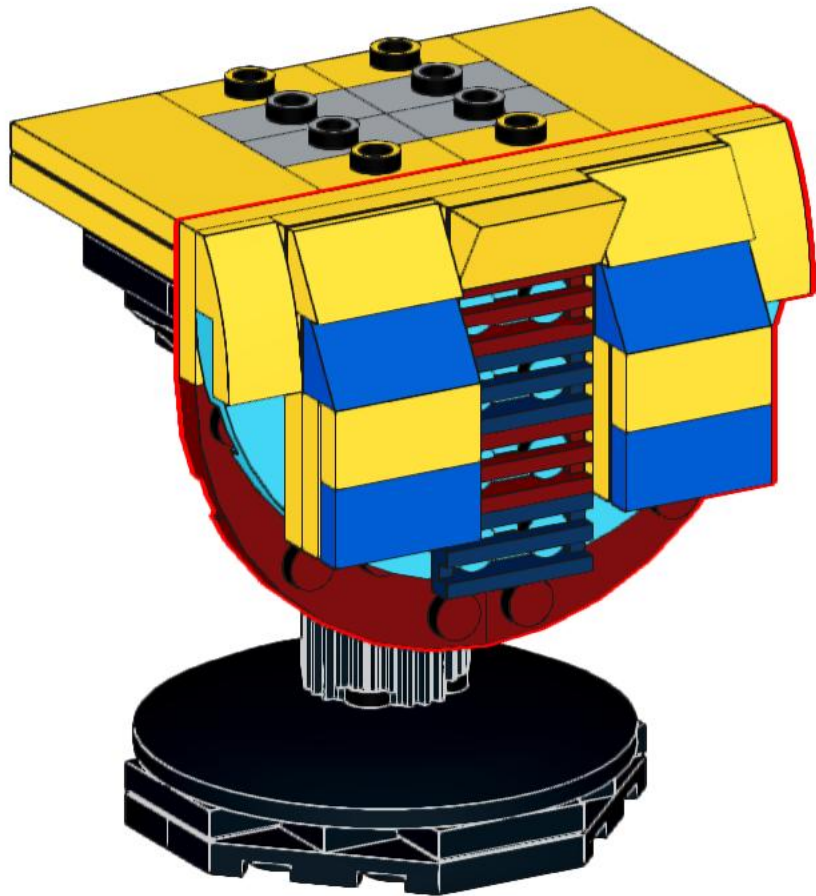

# 20

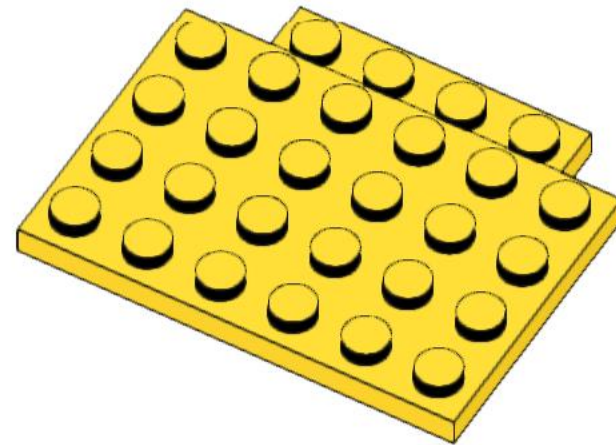
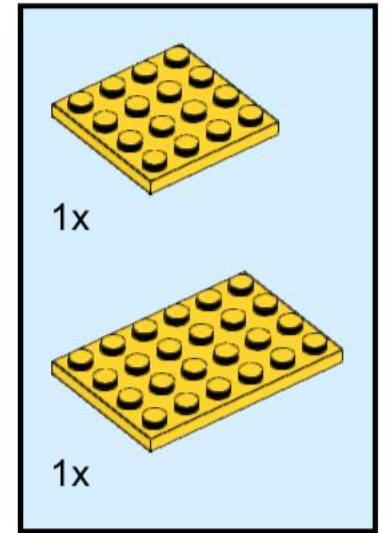
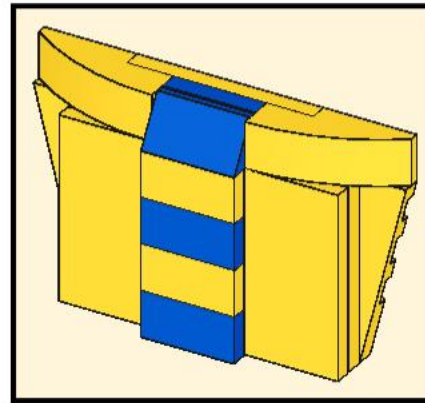

# 21

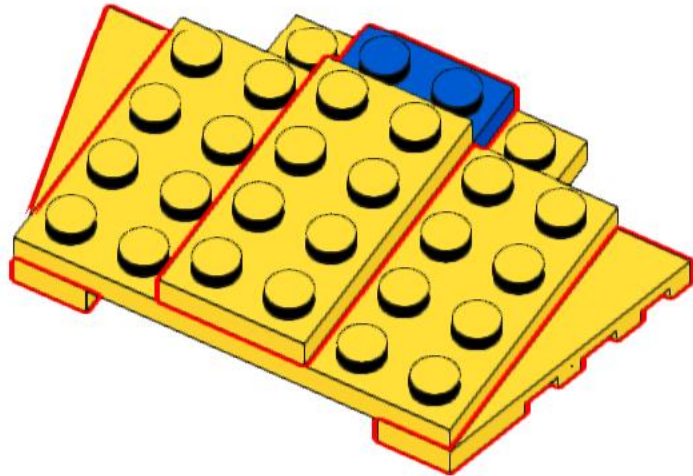
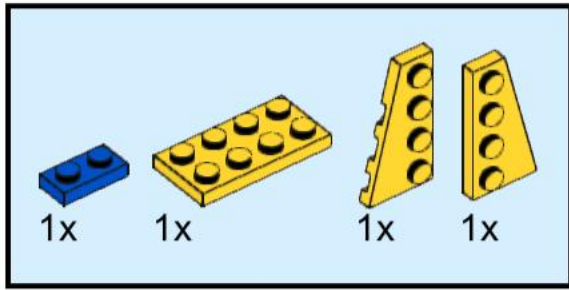

# 22

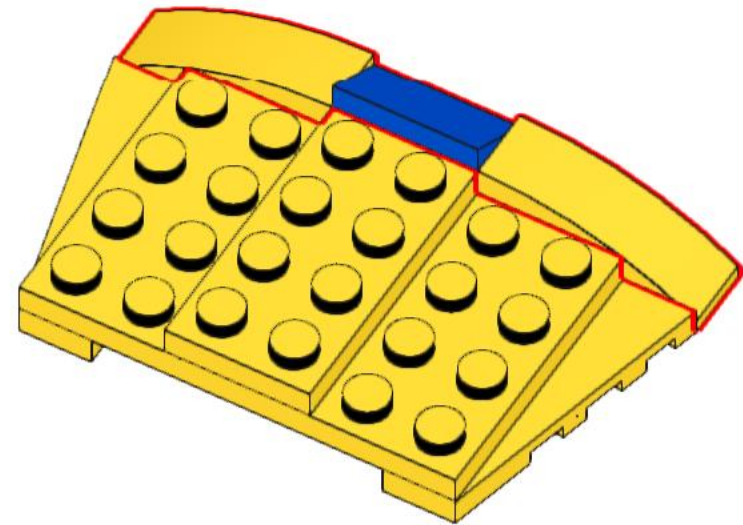
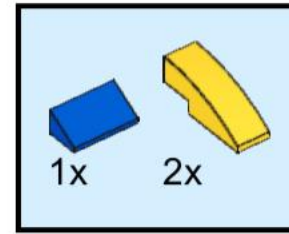



# 23

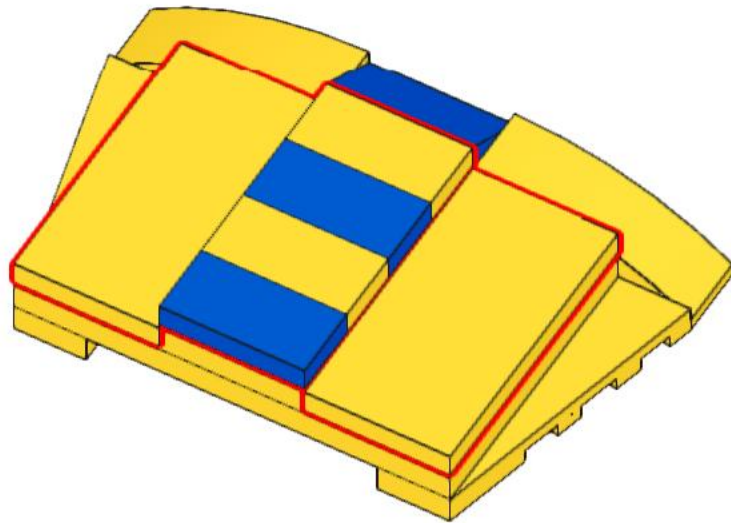
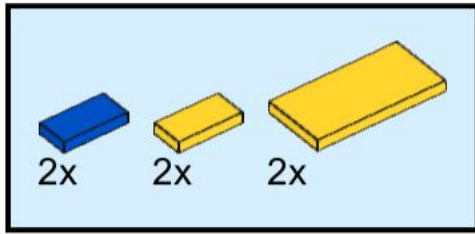

# 24

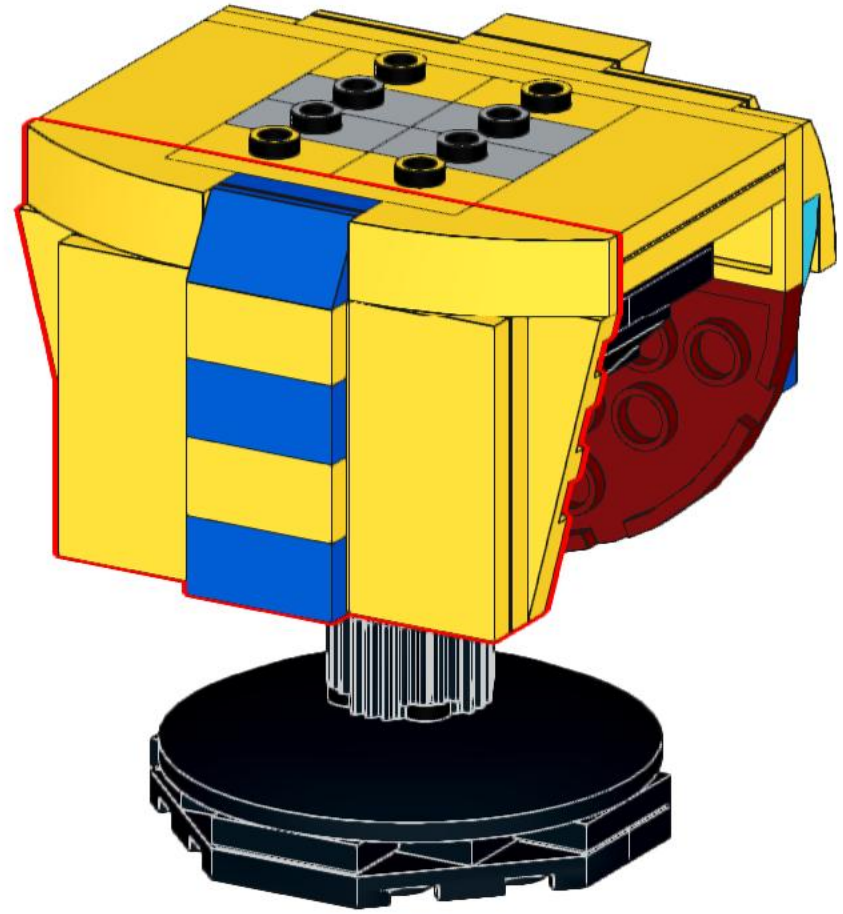

# 25

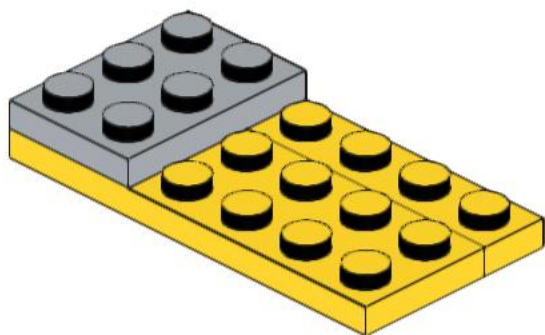
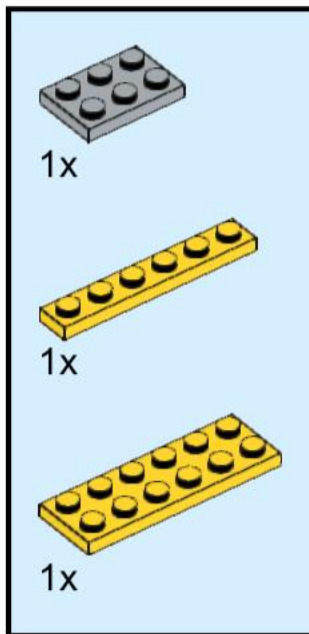

# 26

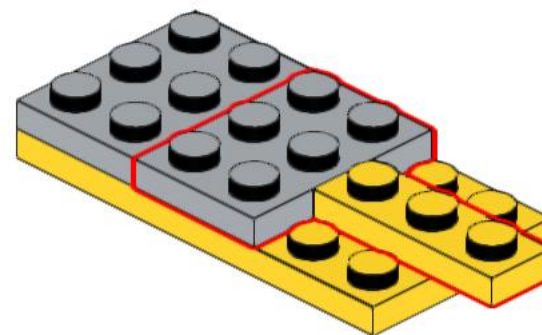
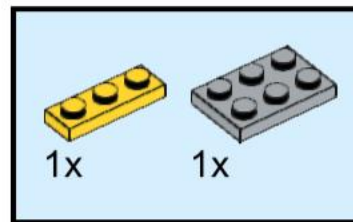

# 27

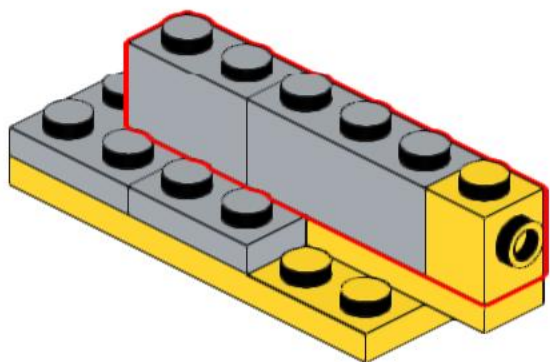
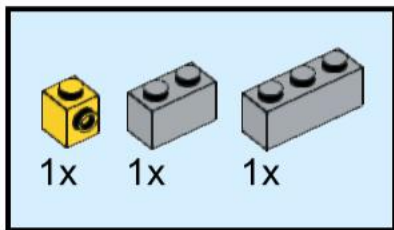

# 28

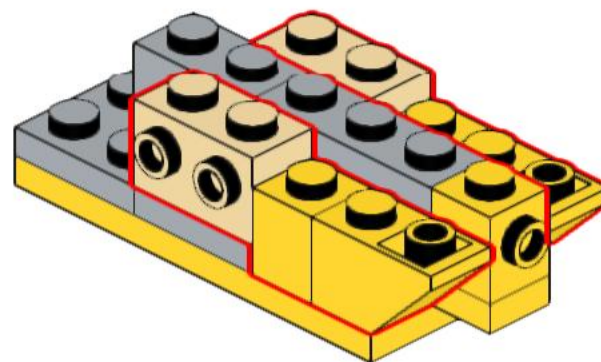
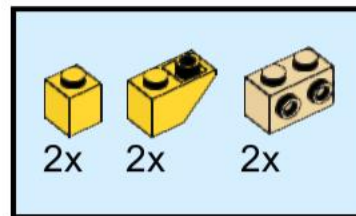



# 29

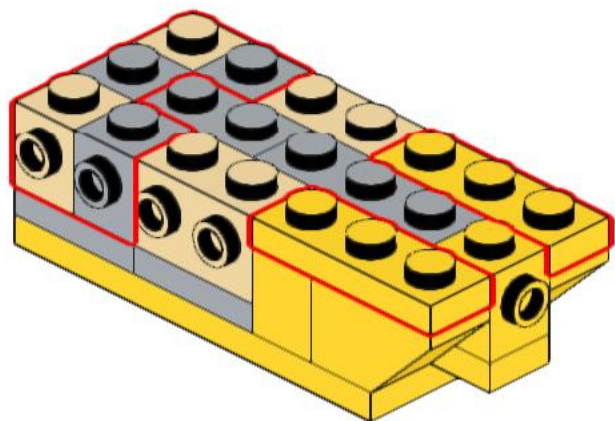
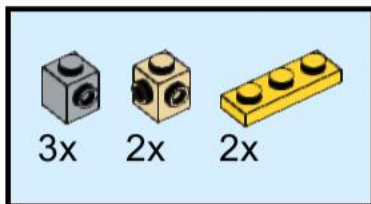

# 30

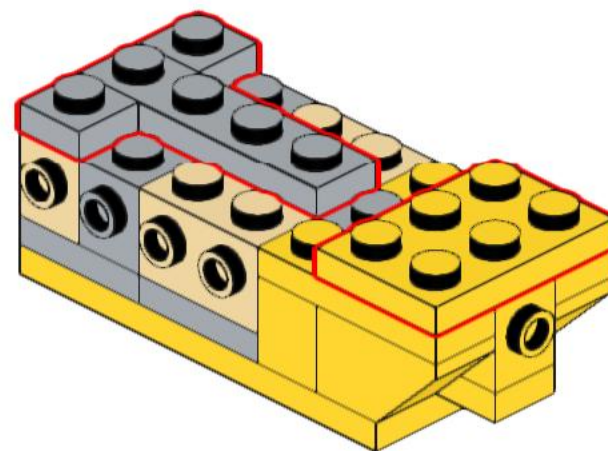
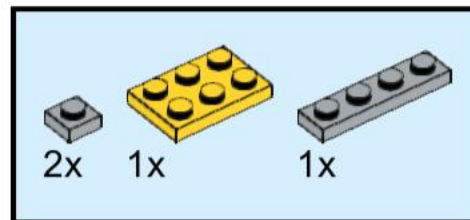

# 31

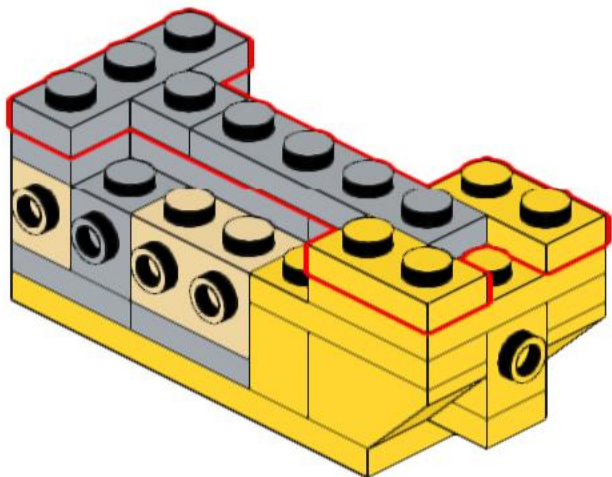
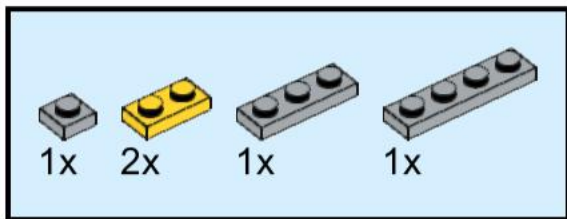

# 32

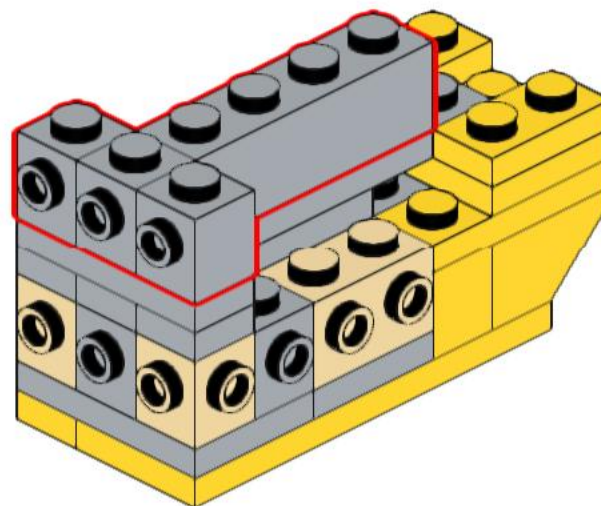
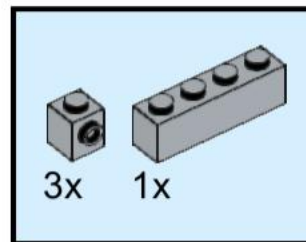

# 33

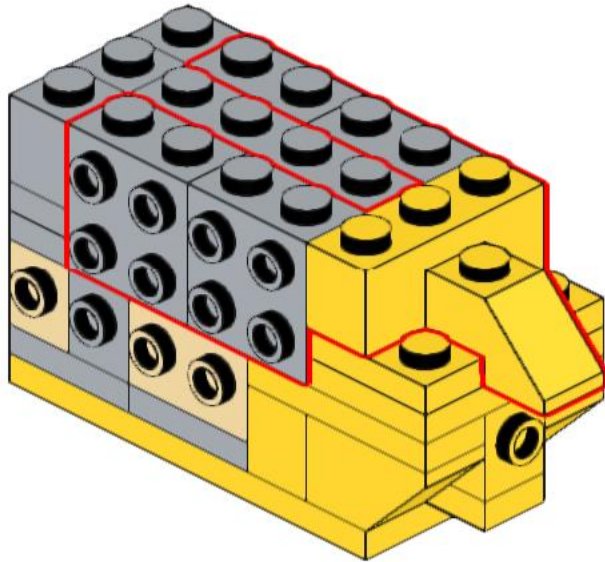
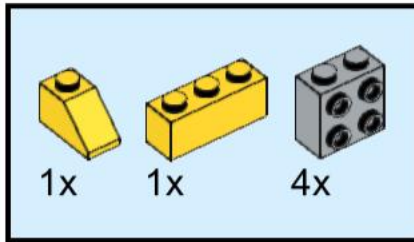

# 34

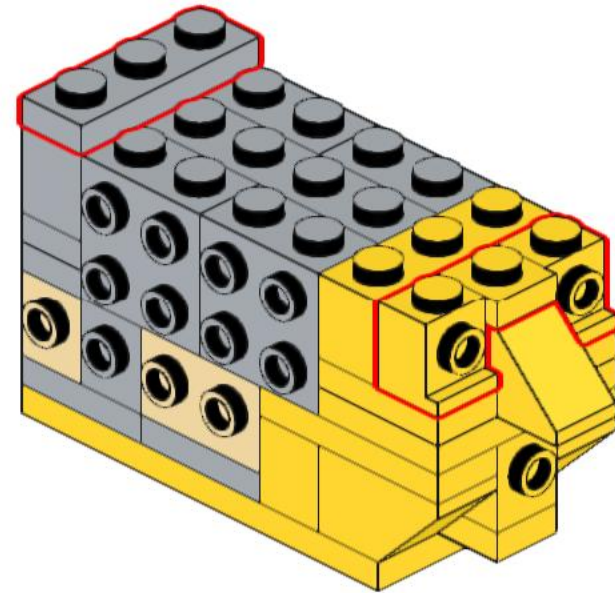
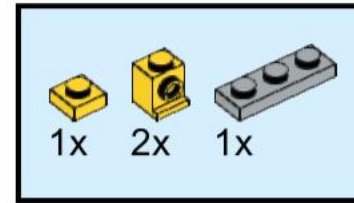



# 35

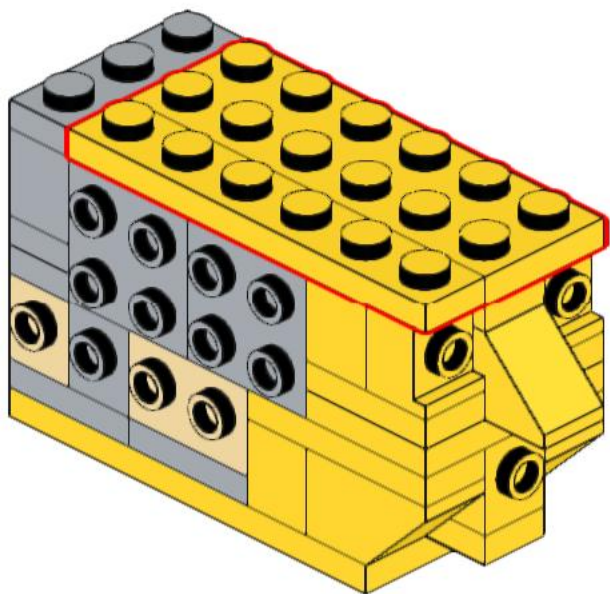
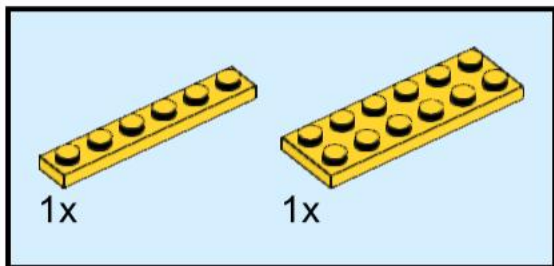

# 36

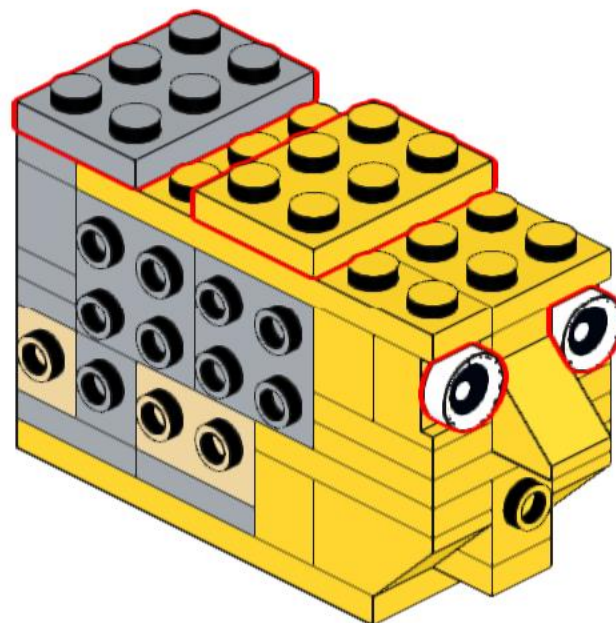
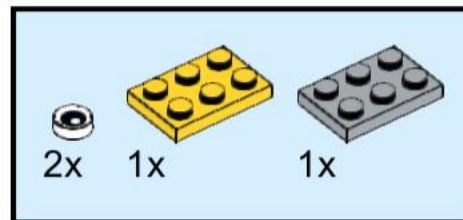

# 37

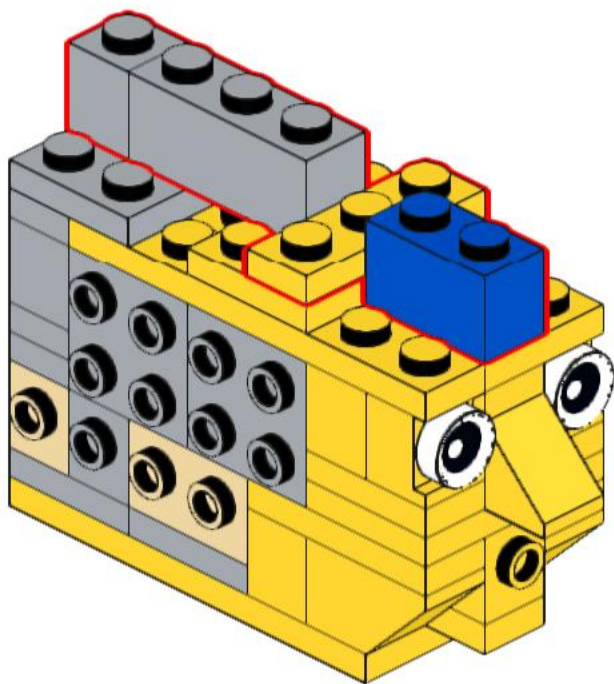
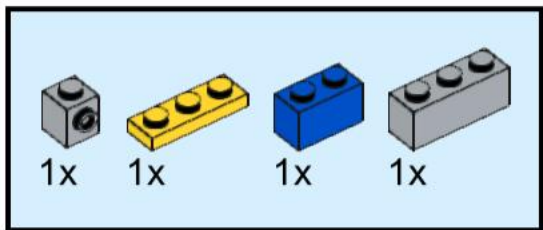

# 38

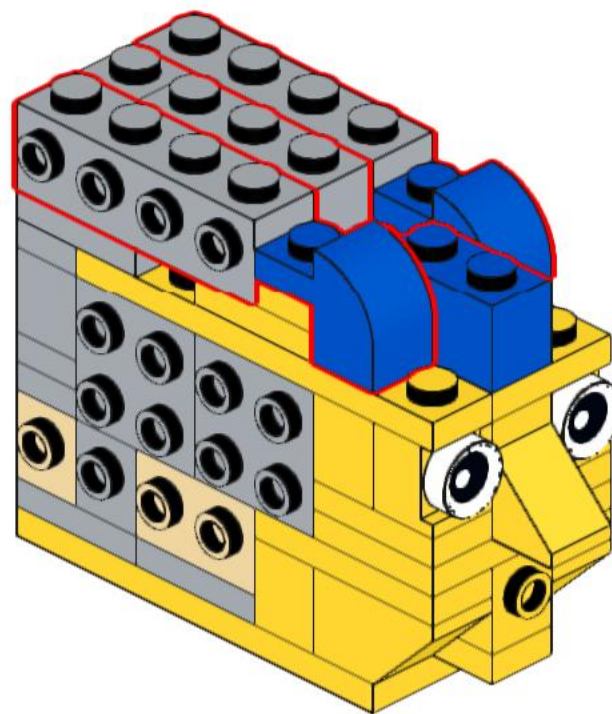
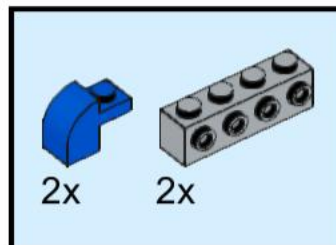

# 39

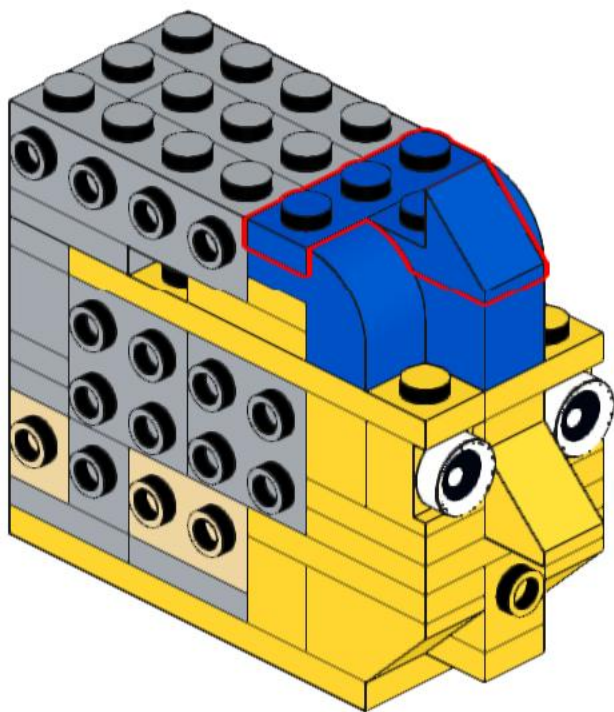
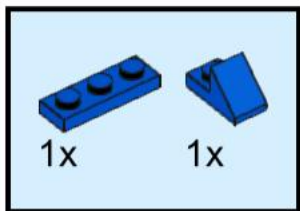

# 40

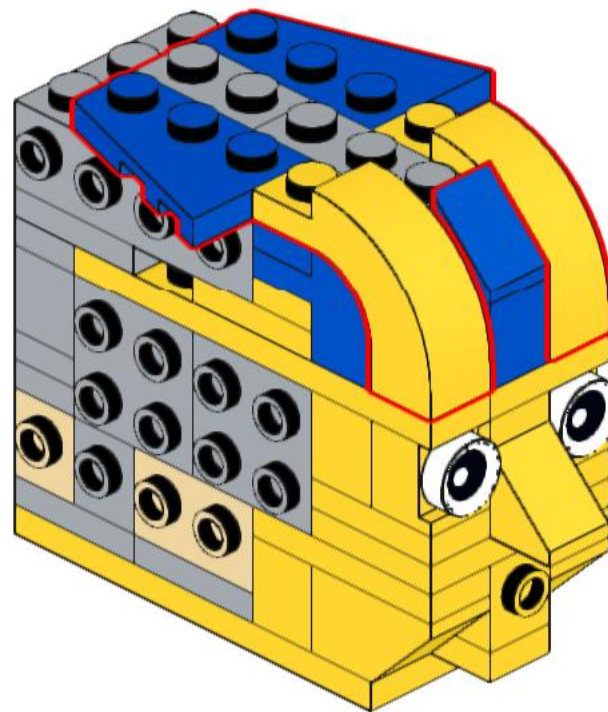
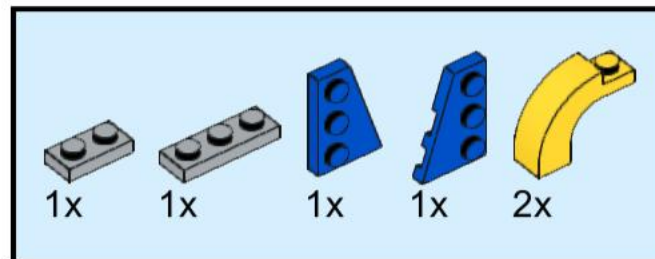



# 41

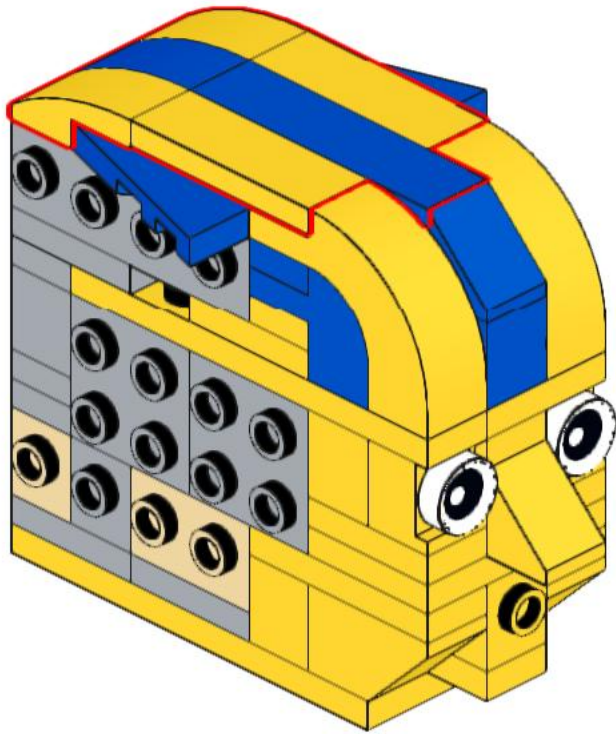
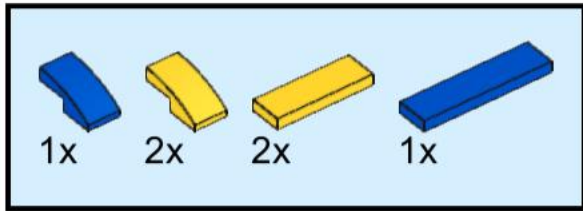

# 42

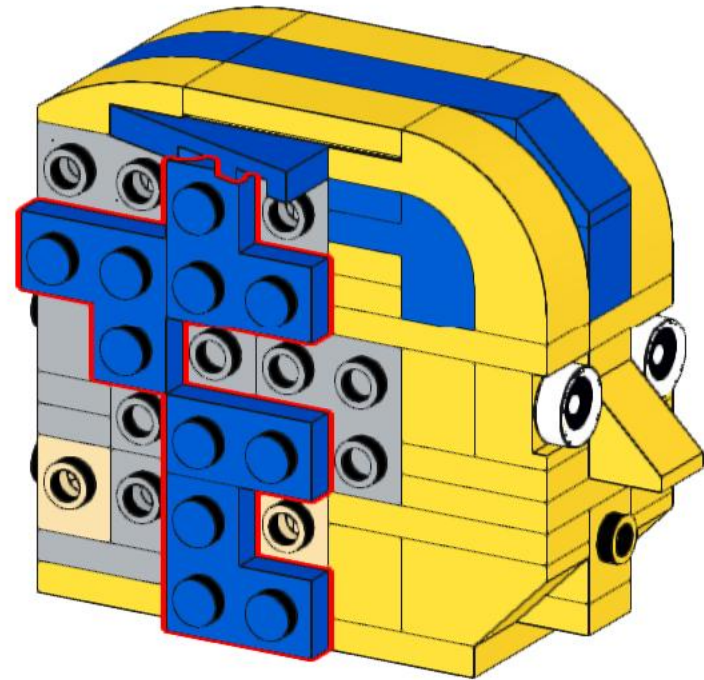
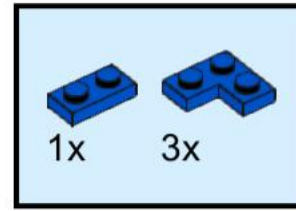



# 43

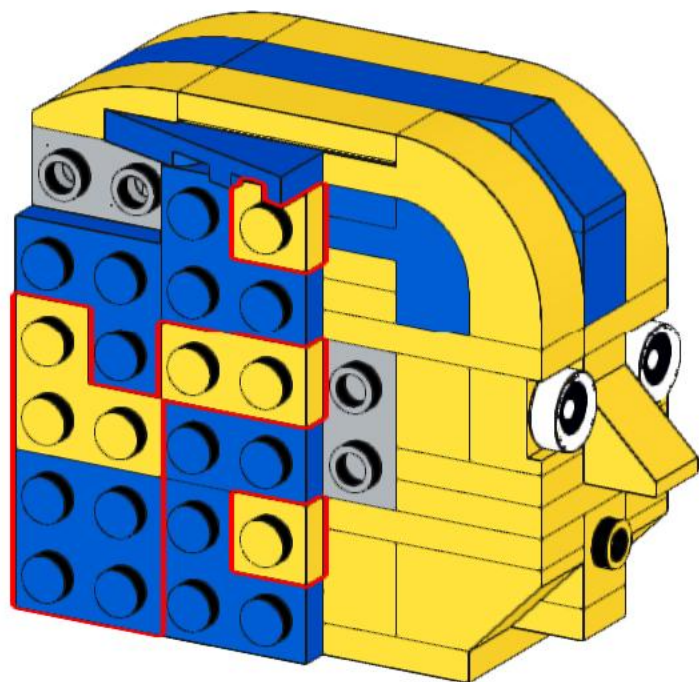
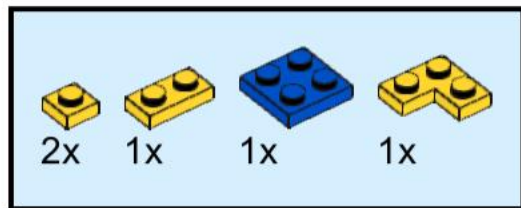

# 44

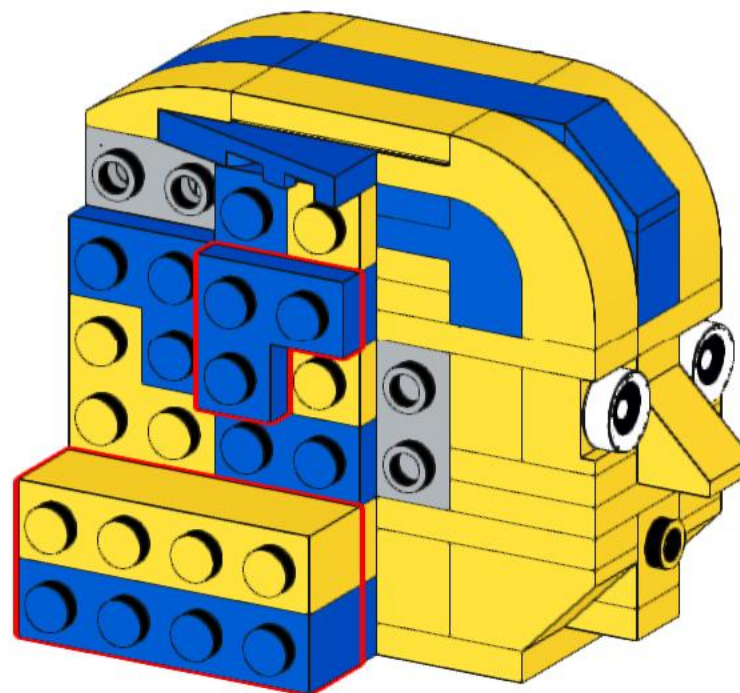
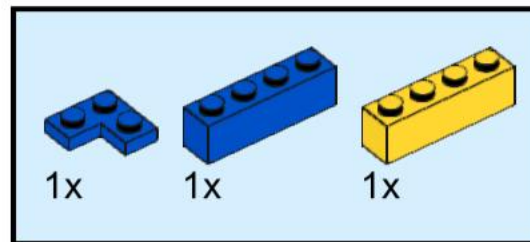

# 45

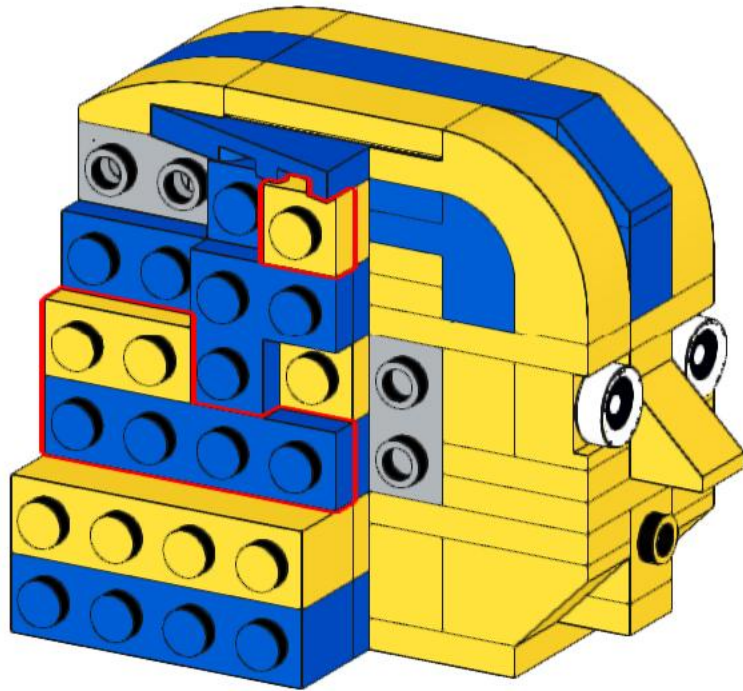
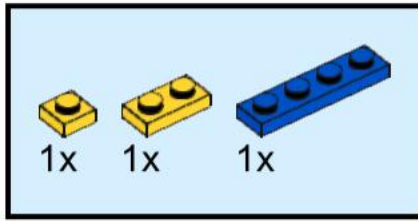

# 46

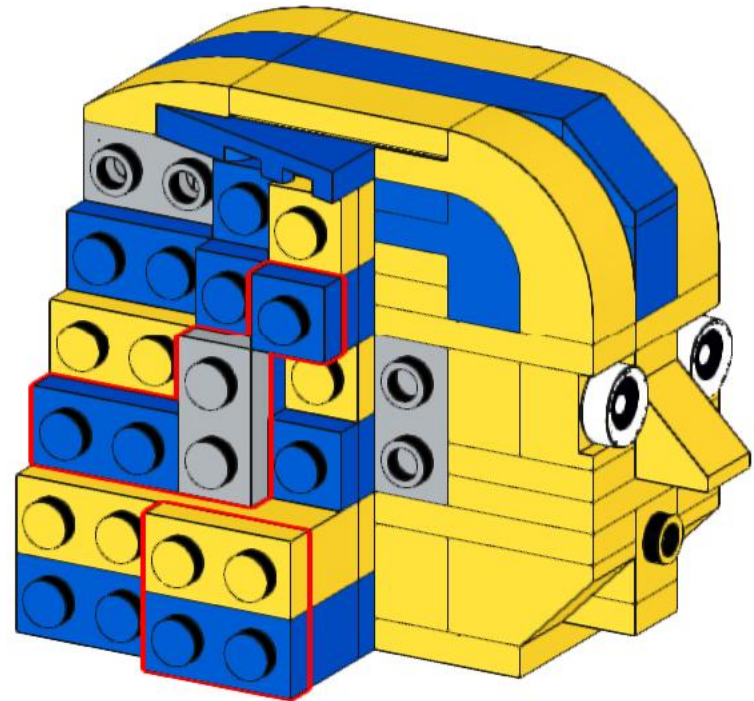
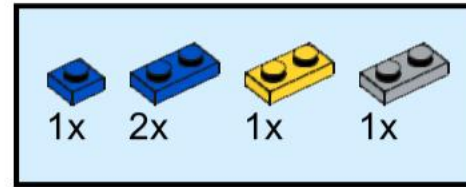

# 47

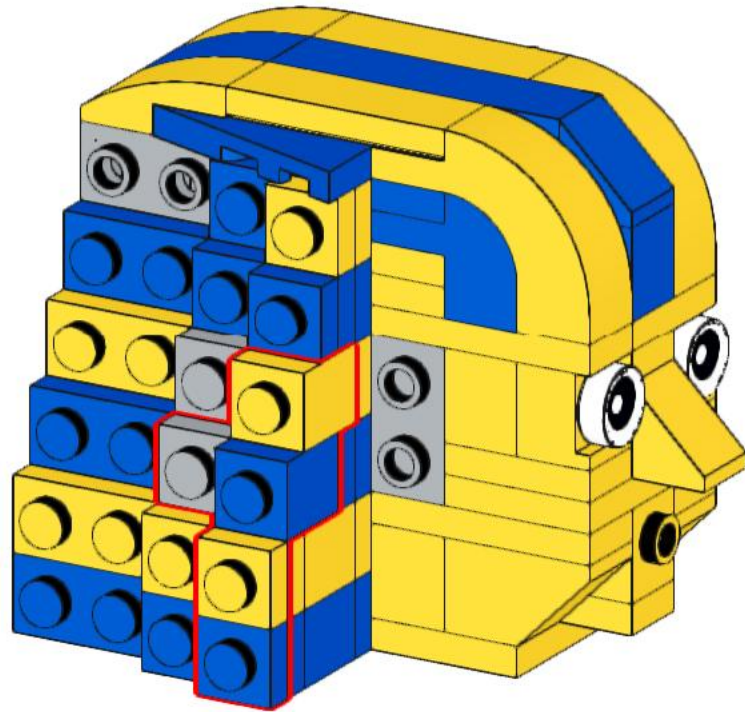
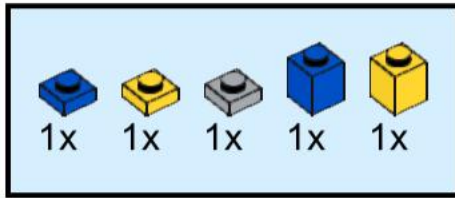

# 48

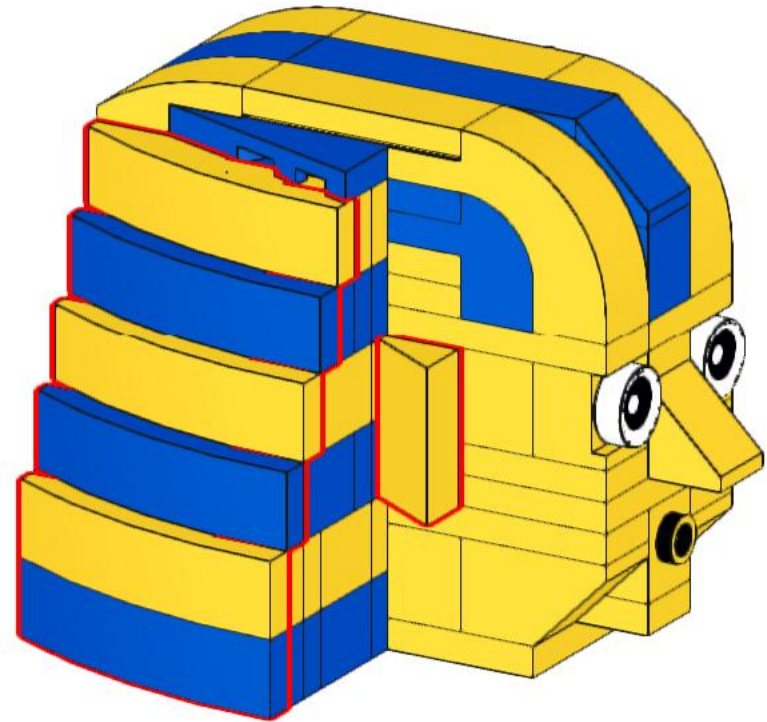
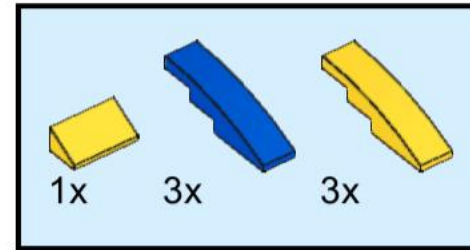



# 49

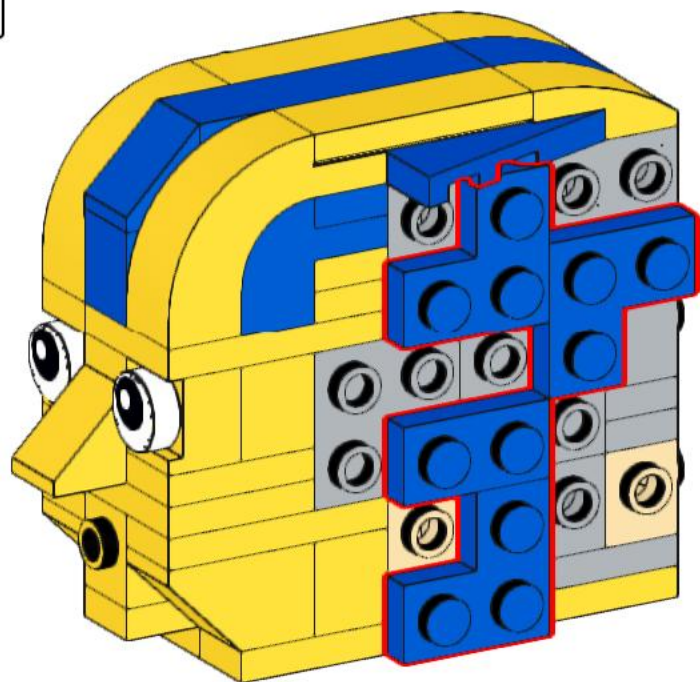
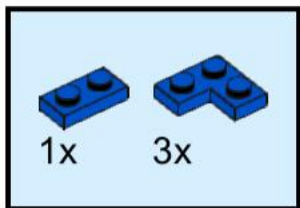

# 50

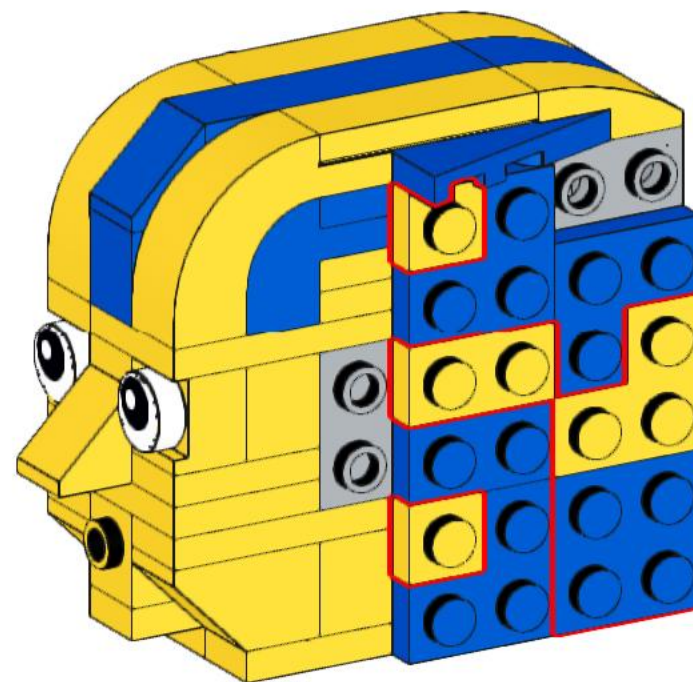
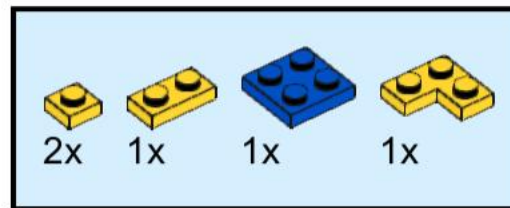



# 51

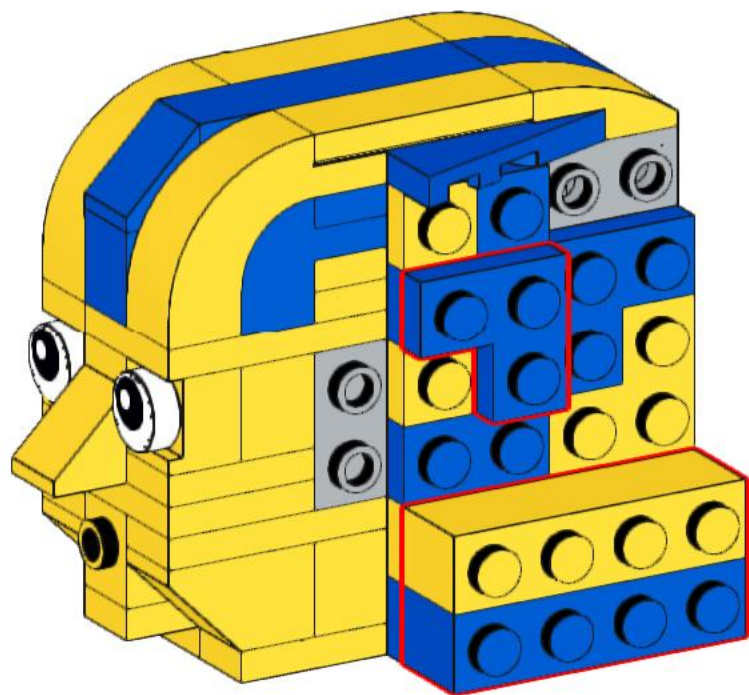
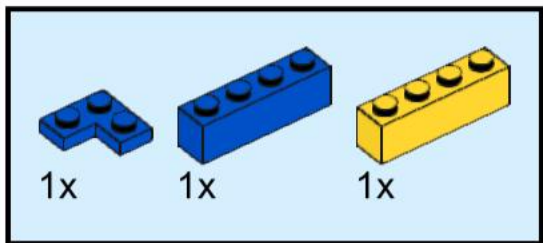

# 52

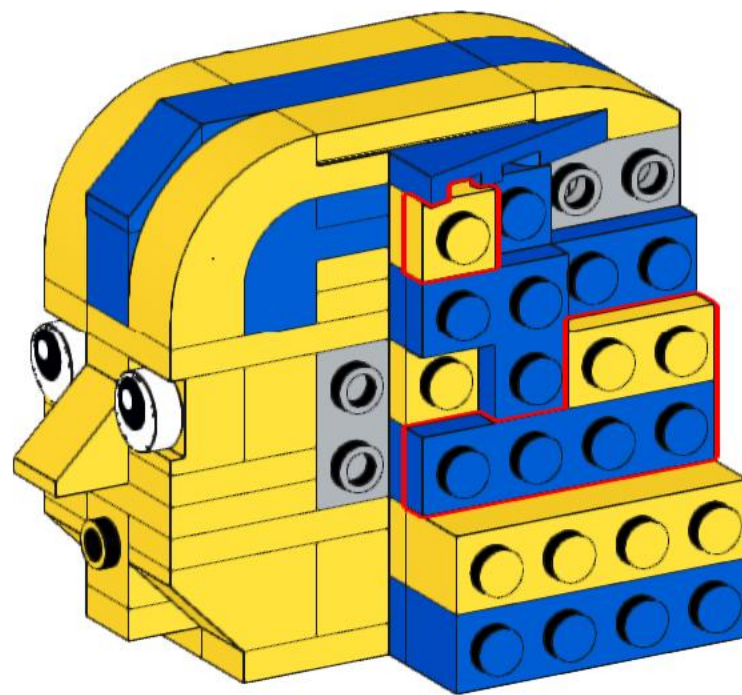
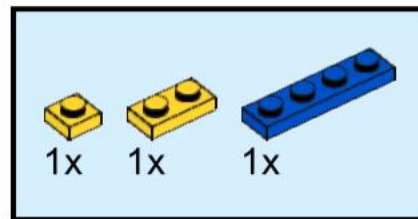

# 53

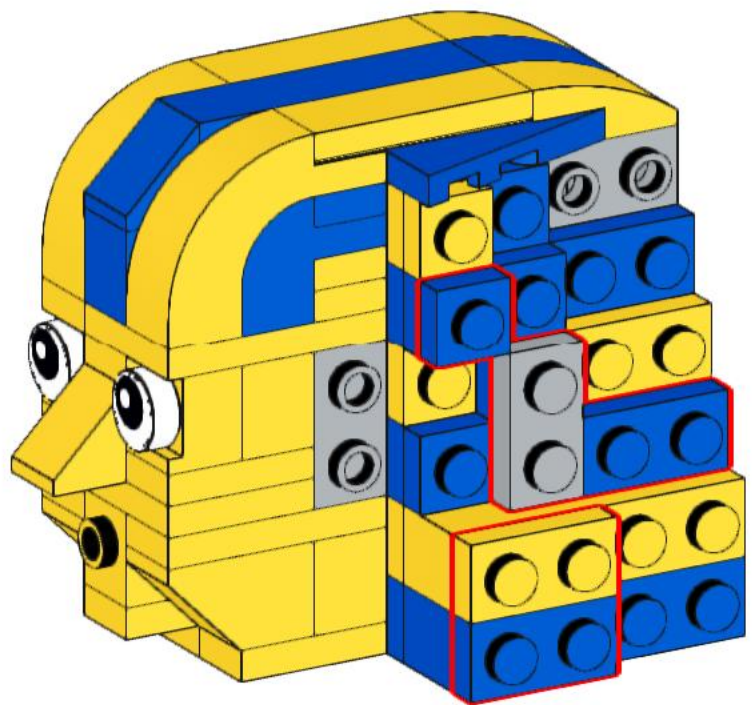
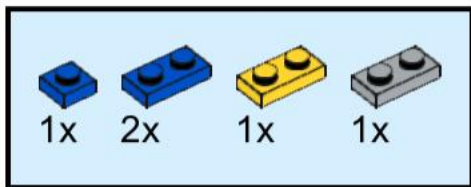

# 54

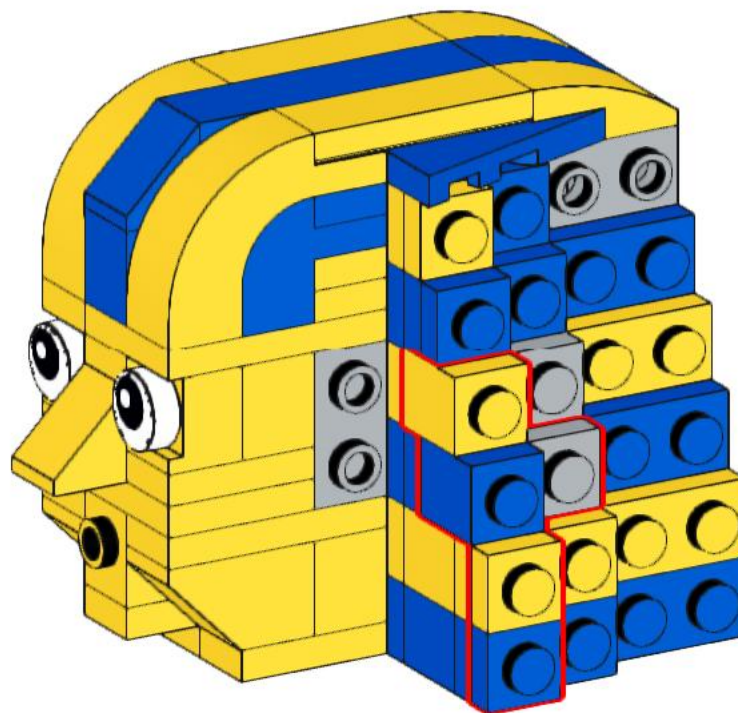
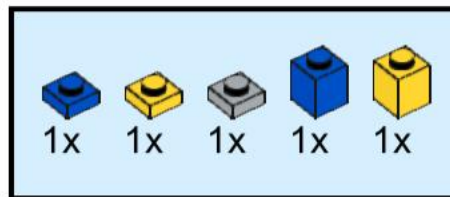

# 55

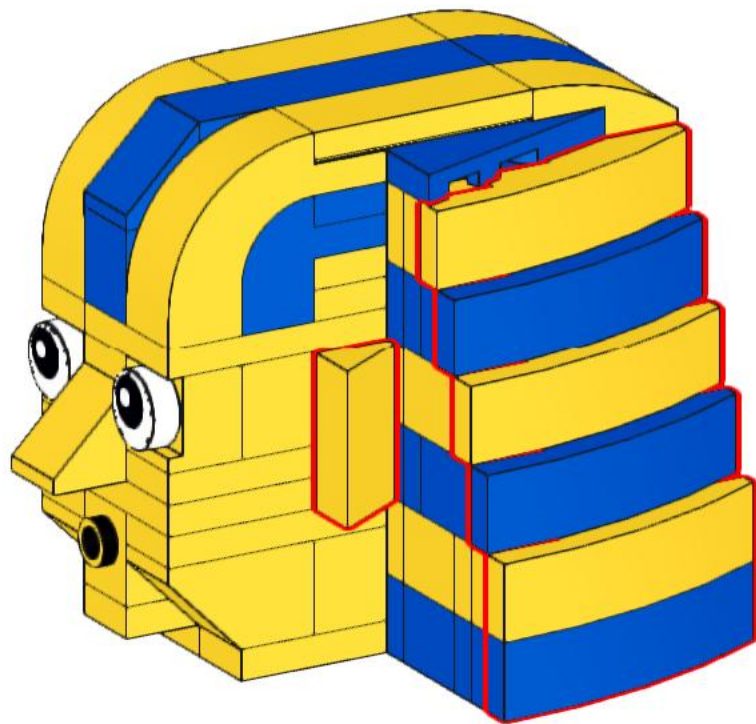
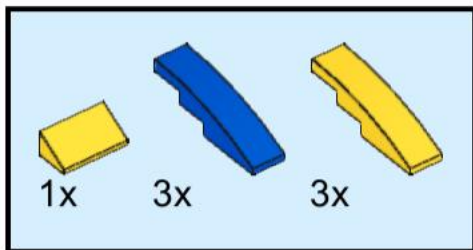

# 56

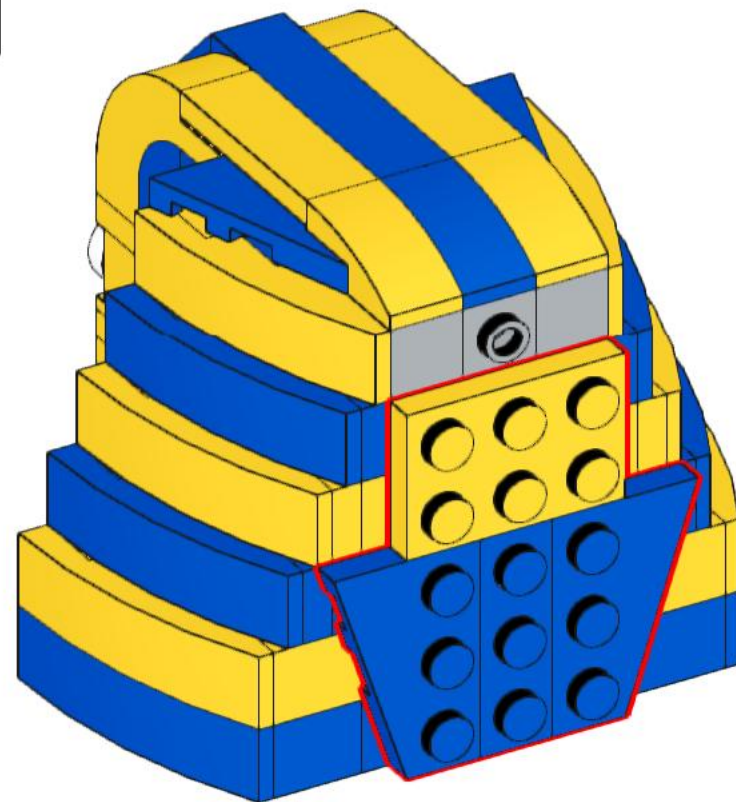
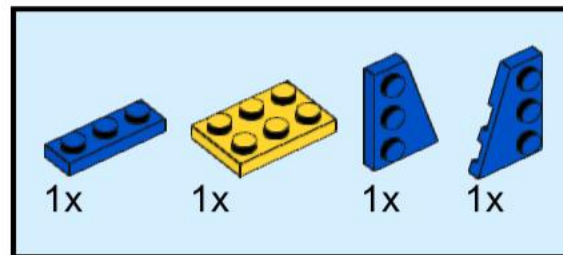



# 57

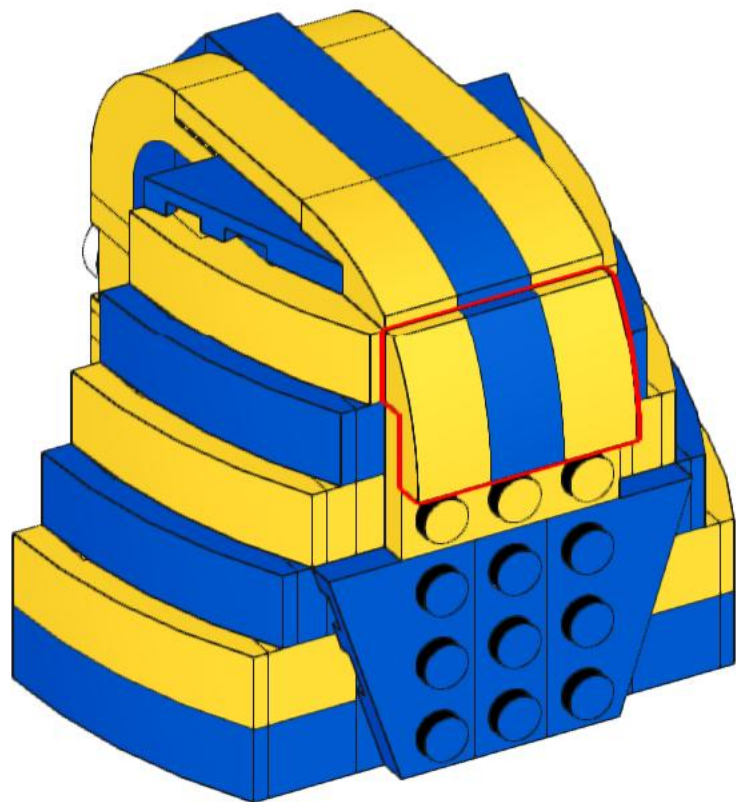
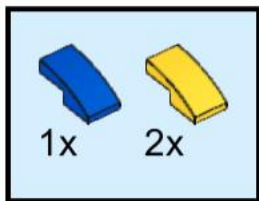

# 58

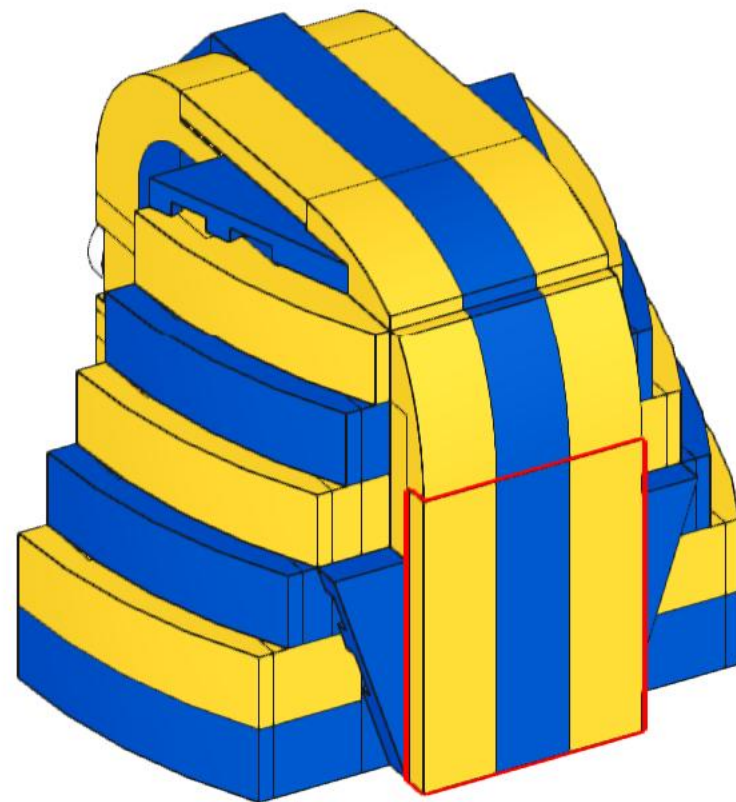
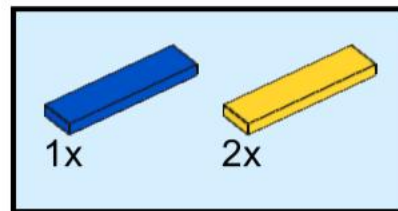



# 59

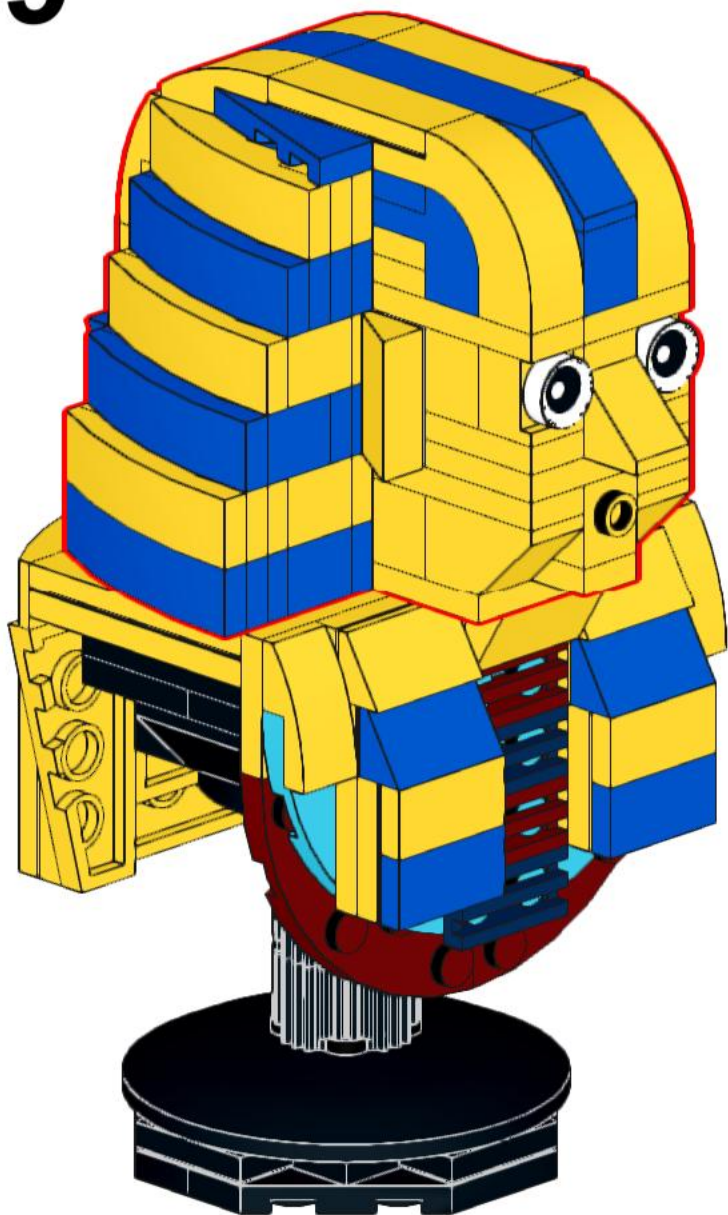

# 60

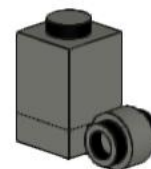
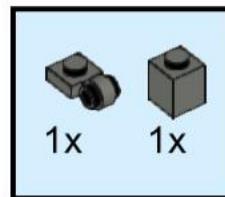
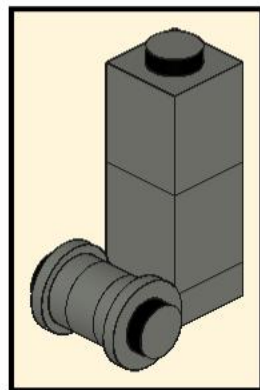

# 61

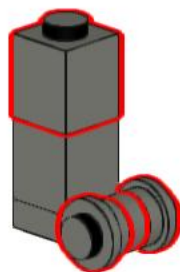
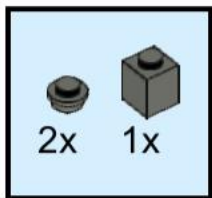

# 62

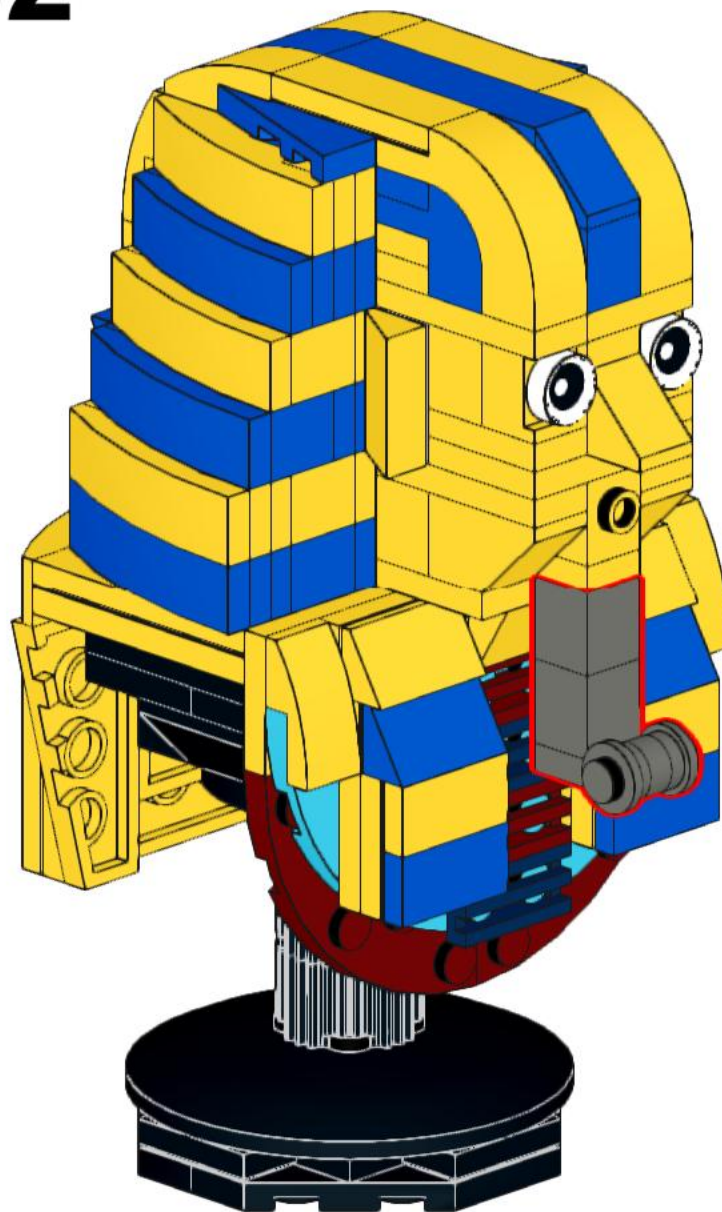

4x  
3069b, 11



2x  
3020, 11



2x  
2419, 11



1x  
4032, 11



1x  
3031, 11



2x  
3660, 11



1x  
60474, 11

1x  
44375b, 11



3x  
92947, 11



2x  
4073, 85



2x  
3710, 11



1x  
3706, 11



2x  
3005, 85



2x  
30414, 11



2x  
87609, 11



1x  
4081b, 85



5x  
3024, 86



7x  
87087, 86



3x  
3623, 86



1x  
3020, 86



9x  
3024, 3



6x  
11477, 3



3x  
3023, 86



2x  
3622, 86



2x  
98138pb007, 1



4x  
3005, 3

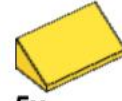

5x  
85984, 3



4x  
15573, 86



3x  
3021, 86



2x  
2412b, 59



2x  
4070, 3



1x  
3040, 3

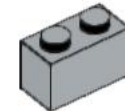

1x  
3004, 86



2x  
3710, 86

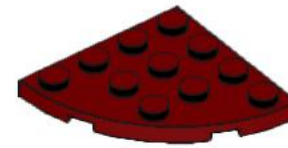

2x  
30565, 59



1x  
87087, 3

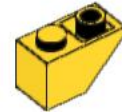

2x  
3665, 3

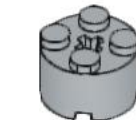

1x  
3941, 86

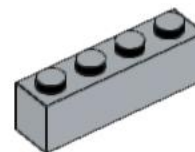

1x  
3010, 86



2x  
26604, 2

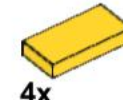

4x  
3069b, 3



2x  
2420, 3

2x  
3710, 11

1x  
3706, 11

2x  
3005, 85

1x  
3941, 86

1x  
3010, 86

2x  
26604, 2

9x  
3023, 3

2x  
3022, 3

2x  
30414, 11

2x  
87609, 11

1x  
4081b, 85

5x  
3024, 86

4x  
22885, 86

2x  
30414, 86

2x  
11211, 2

4x  
15573, 3

2x  
3022, 3

4x  
3623, 3



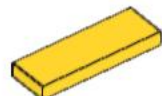

2x  
63864, 3



6x  
61678, 3

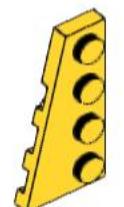

1x  
41770, 3

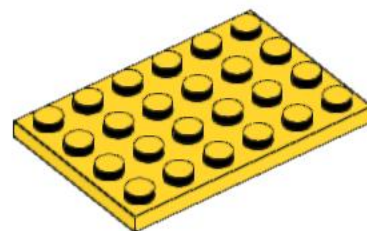

1x  
3032, 3



2x  
2412b, 63



1x  
92946, 7



2x  
43723, 7

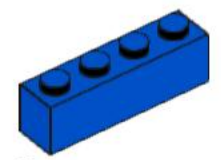

2x  
3010, 7



2x  
50950, 3

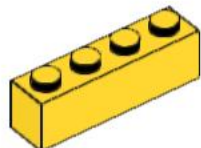

2x  
3010, 3

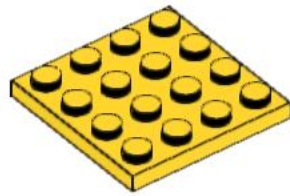

1x  
3031, 3

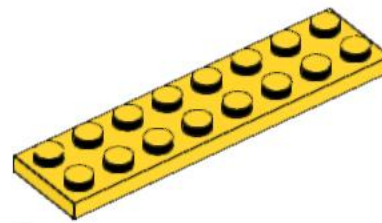

1x  
3034, 3



4x  
3024, 7

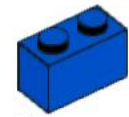

1x  
3004, 7



2x  
43722, 7

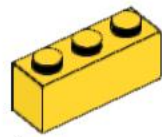

1x  
3622, 3

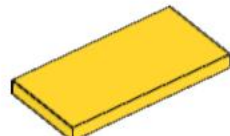

4x  
87079, 3

1x  
3031, 3

1x  
3034, 3



2x  
3005, 7



2x  
6091, 7



2x  
2431, 7

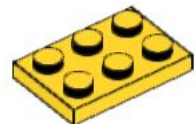

5x  
3021, 3

4x  
87079, 3

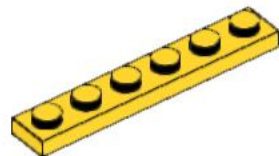

3x  
3666, 3

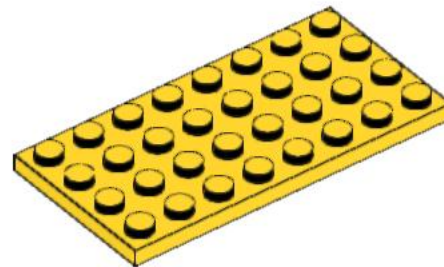

1x  
3035, 3



7x  
3023, 7

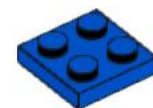

2x  
3022, 7

2x  
2431, 7



2x  
6005, 3

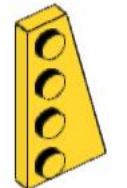

1x  
41769, 3

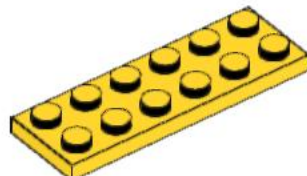

2x  
3795, 3

1x  
3035, 3



4x  
3069b, 7

2x  
3022, 7

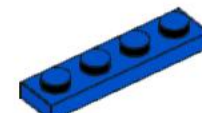

2x  
3710, 7

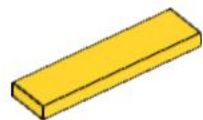

2x  
2431, 3

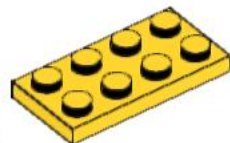

1x  
3020, 3

2x  
3795, 3

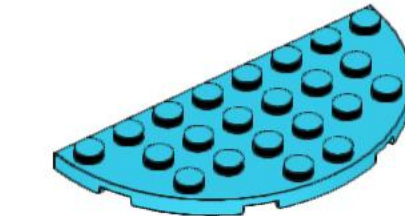

1x  
22888, 156



2x  
11477, 7



8x  
2420, 7

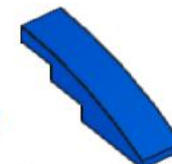

6x  
61678, 7



3x  
85984, 7



2x  
3623, 7